

FriendlyNet
Fast Ethernet Switch
FS4004DS/FS4008DS
User's Manual



FriendlyNet

Fast Ethernet Switch

FS4004DS/FS4008DS

User's Manual

Asanté Technologies, Inc.
821 Fox Lane
San Jose, CA 95131
1.800.662.9686
www.asante.com

September 1997

Part Number: 06-00384-00 Rev. A

Copyright Notice

Copyright 1997 by Asanté Technologies, Inc.

All rights reserved. No part of this manual, or any associated artwork, software, product design or design concept, may be copied, reproduced or stored, in whole or in part, in any form or by any means mechanical, electronic, optical, photocopying, recording or otherwise, including translation to another language or format, without the express written consent of Asanté Technologies, Inc.

Trademarks

Asanté Technologies and FriendlyNet are trademarks of Asanté Technologies, Inc. Ethernet is a registered trademark of the Xerox Corporation. All brand names and products are trademarks or registered trademarks of their respective holders.

FCC Information

This device complies with part 15 of the FCC Rules. Operation is subject to the following two conditions: (1) this device may not cause harmful interference and (2) this device must accept any interference received, including interference that may cause undesired operation.

Operation of this equipment in a residential area is likely to cause interference, in which case, the user, at his or her own risk and expense, will be required to correct the interference.

Asanté Warranty

Asanté Technologies, Inc. warrants that this product will be free from defects in title, materials and manufacturing workmanship. If the product is found to be defective, then, as your sole remedy and as the manufacturer's only obligation, Asanté Technologies, Inc. will repair or replace the product.

This warranty is exclusive and is limited to the FriendlyNet Fast Ethernet Switch. This warranty shall not apply to products that have been subjected to abuse, misuse, abnormal electrical or environmental conditions, or any condition other than what can be considered normal use.

Warranty Disclaimers

Asanté Technologies, Inc. makes no other warranties, express, implied or otherwise, regarding the FriendlyNet Fast Ethernet Switch, and specifically disclaims any warranty for merchantability or fitness for a particular purpose.

The exclusion of implied warranties is not permitted in some states and the exclusions specified herein may not apply to you. This warranty provides you with specific legal rights. There may be other rights that you have which vary from state to state.

Limitation of Liability

The liability of Asanté Technologies, Inc. arising from this warranty and sale shall be limited to a refund of the purchase price. In no event shall Asanté Technologies, Inc. be liable for costs of procurement of substitute products or services, or for any lost profits, or for any consequential, incidental, direct or indirect damages, however caused and on any theory of liability, arising from this warranty and sale. These limitations shall apply notwithstanding any failure of essential purpose of any limited remedy.

Table of Contents

About This Manual	v
Chapter Contents	v
Document Conventions	vi
Introduction	1-1
FriendlyNet Fast Ethernet Switch	1-1
Features	1-2
Performance Features	1-3
Fast Ethernet and Switching Technology	1-3
Fast Ethernet Technology	1-3
Switching Technology	1-4
Switch acts as a bridge between network segments	1-4
Switch supports network expansion	1-4
Installation	2-1
Package Contents	2-1
Components	2-2
FS4004DS	2-2
FS4008DS	2-3
Cabling and Voltage Requirements	2-4
Mounting Configurations	2-5
Desktop Mounting	2-5
Wall Mounting the FS4004DS	2-6
Rack Mounting the FS4008DS	2-7

Connecting Network Devices	2-8
Connecting a PC to the Switch	2-8
Connecting a Hub to the Switch	2-9
Connecting a Hub without an Uplink Port to the Switch	2-10
Connecting the Switch to Another Switch or Network Device	2-11
Powering on the Switch	2-12
FS4004DS	2-12
FS4008DS	2-12
LED Indicators	3-1
LED Indicators on the Switch	3-1
LED Indicators for Power Connections	3-2
LED Indicators for Port Connections	3-3
Link/Activity LED	3-3
100Mbps Operation LED	3-3
FDX/Col LED	3-4
LED Indicators for Switch Connections	3-5
PC to Switch Connection	3-5
Switch to Hub Connection	3-5
Switch to Switch or other Network Devices Connection	3-6
Troubleshooting	A-1
Specifications	B-1
Technical Support	C-1

About This Manual

This manual discusses two models of the FriendlyNet Fast Ethernet Switch:

- ❑ **FS4004DS** — four-port 10/100Mps Fast Ethernet Switch
- ❑ **FS4008DS** — eight-port 10/100Mps Fast Ethernet Switch

These models are similar in every respect except for the number of ports. Therefore, unless otherwise noted, all information provided in this manual is applicable to both.

Chapter Contents

This manual is divided into the following chapters and appendices:

- ❑ Chapter 1, “Introduction,” describes the FriendlyNet FS4004DS and FriendlyNet FS4008DS Fast Ethernet Switch and their features.
- ❑ Chapter 2, “Installation,” explains how to install, mount, and power on the FriendlyNet Fast Ethernet Switch.
- ❑ Chapter 3, “LED Indicators,” describes how to interpret the FriendlyNet Fast Ethernet Switch’s LEDs.
- ❑ Appendix A, “Troubleshooting,” explains how to troubleshoot problems by monitoring the FriendlyNet Fast Ethernet Switch’s LEDs.

About This Manual

- ❑ Appendix B, “Specifications,” describes the FriendlyNet Fast Ethernet Switch’s technical specifications.
- ❑ Appendix C, “Technical Support” explains how to contact Asanté Technical Support.

Document Conventions

This manual uses the terms “Switch” (first letter upper case) to refer to the FriendlyNet FS4004DS or FS4008DS 10/100Mbps Fast Ethernet Switch, and “switch” (first letter lower case) to refer to all other Ethernet switches.

This manual uses the following conventions to convey instructions and information:

- ❑ Commands and key words are in **boldface** font.
 - △ **Note:** Noteworthy information, which contains helpful suggestions or references to other sections in the manual, is in this format.
 - ▲ **Important!** Significant information that calls attention to important features or instructions is in this format.

Introduction

This chapter introduces the FriendlyNet Fast Ethernet Switch. It also provides an overview of Fast Ethernet and switching technology.

FriendlyNet Fast Ethernet Switch

Thank you for purchasing the Asanté FriendlyNet FS4004DS or the FriendlyNet FS4008DS 10/100Mbps Fast Ethernet Switch.

The FS4004DS and FS4008DS are unmanaged 10/100 Fast Ethernet switches designed to address increasing network bandwidth needs and accommodate future network expansion.



Figure 1-1 FriendlyNet FS4004DS



Figure 1-2 FriendlyNet FS4008DS

Each Switch is simple to install and features power, collision, full duplex, 10/100Mbps, and link/activity LEDs for easy monitoring of the Switch and its ports.

For network expansion, each Switch has an uplink port that makes it easy to connect it to another Fast Ethernet switch.

Introduction

Features

The FriendlyNet FS4004DS and the FS4008DS have the following features:

- ❑ Compact size — designed for small to large workgroups in space-limited areas; installs on desktop, mounts on wall, or installs in a standard equipment rack (depends on model)
- ❑ Plug-and-play installation
- ❑ Connects from four to eight (depends on model) 10Base-T or 100Base-TX segments per switch
- ❑ Contains an uplink/ MDI-II (media dependent interface) port for uplink to another switch
- ❑ Auto-negotiation on all ports to determine network speed
- ❑ Full- or half-duplex operation on all ports
- ❑ Allows cascading from any port to any number of switches
- ❑ Complies with the IEEE 802.3u Fast Ethernet standard
- ❑ Works with Category 5 UTP (unshielded twisted-pair) cable
- ❑ Contains power, collision, full duplex, 10/100Mbps, and link/activity LEDs to aid network diagnosis and simple management
- ❑ Ideal for deployment with multiple high-speed servers for dedicated bandwidth 10Mbps or 100Mbps workgroups
- ❑ Combines dynamic memory allocation with store-and-forward switching

Performance Features

The FriendlyNet FS4004DS and the FS4008DS have the following performance features:

- ❑ Store-and-forward switching scheme ensures data integrity
- ❑ N-Way auto-negotiation on all ports automatically senses port speed (10/100 Mbps) and duplex mode (full duplex or half duplex)
- ❑ Data forwarding rate of 148,800pps (packets per second) per port at 100% of wire-speed
- ❑ Data filtering rate of 148,800pps per port at 100% of wire-speed
- ❑ 8K active MAC address entry table per device (self-learning)
- ❑ 8MB (FS4008DS) or 4MB (FS4004DS) packet buffer per device (dynamically allocated for each port)

Fast Ethernet and Switching Technology

This section provides a brief overview of Fast Ethernet and Ethernet switching technology.

Fast Ethernet Technology

Fast Ethernet, or 100Base-T, represents a non-disruptive, smooth evolution from the current 10Base-T technology.

The 100Mbps Fast Ethernet technology:

- ❑ Extends the 10Mbps Ethernet standard to transmit and receive data at 100Mbps
- ❑ Maintains the CSMA/CD Ethernet protocol
- ❑ Allows for simple upgrades, since it is compatible with all other 10Mbps Ethernet environments
- ❑ Takes advantage of your company's existing investment in hardware, software and personnel training

Switching Technology

An Ethernet switch is a device that can direct network traffic among several Ethernet and Fast Ethernet networks.

A switch increases network capacity and decreases network loading by making it possible for a LAN to be divided into different *segments*.

Switch acts as a bridge between network segments

A switch acts as a high-speed selective bridge between individual segments.

Traffic that needs to go from one segment to another is automatically forwarded by a switch, without interfering with any other segments. This allows the total network capacity to be multiplied, while decreasing network loading.

To ensure network reliability, a switch monitors each of its ports for signal quality and automatically disconnects stations transmitting excessive noise, reconnecting them when the problem is resolved.

A switch automatically truncates data packets that exceed the maximum length for IEEE 802.3u, preventing a device from blocking the network by transmitting continuous data streams or extra-long packets.

Switch supports network expansion

For Fast Ethernet networks, a switch is an effective way of eliminating problems of chaining hubs beyond the “two-repeater limit.”

A switch can be used to split parts of the network into different collision domains, making it possible to expand your Fast Ethernet network beyond the 205 meter network diameter limit for 100BASE-TX networks.

Switches supporting both traditional 10Mbps Ethernet and 100Mbps Fast Ethernet are also ideal for bridging between existing 10Mbps networks and new 100Mbps networks.

2

Installation

This chapter explains how to install the FriendlyNet Fast Ethernet Switch. It contains the following sections:

- ❑ Package Contents
- ❑ FriendlyNet Fast Ethernet Switch components
- ❑ Cabling and voltage requirements
- ❑ Mounting configurations
- ❑ Connecting network devices
- ❑ Powering on the Switch

Package Contents

The FriendlyNet FS4004DS and the FS4008DS are shipped with the following items:

- ❑ (1) FriendlyNet 4-port **FS4004DS** or 8-port **FS4008DS** Fast Ethernet Switch
- ❑ (1) AC power cord
- ❑ (4) Self-adhesive rubber feet
- ❑ (1) Wall-mount kit (FS4004DS only) which includes two screws and two screw anchors
- ❑ (1) Rack-mount kit (FS4008DS only) which includes two rack-mounting brackets and mounting screws
- ❑ (1) User's Manual (this book)

Installation

Components

This section describes the front- and back-panel layouts of the FS4004DS and FS4008DS.

FS4004DS

The front panel of the FS4004DS consists of four 10/100 Mbps ports, one Uplink port, and LED indicators. See Figure 2-1.

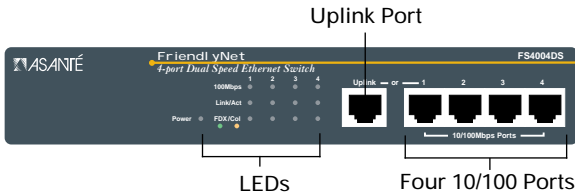

Figure 2-1 FriendlyNet FS4004DS front panel

The back panel of the FS4004DS consists of an AC power connector. See Figure 2-2.



Figure 2-2 FriendlyNet FS4004DS back panel

- △ **Note:** The FS4004DS does not have a power switch. The FS4004DS is automatically powered on as soon as the power cord is connected to the FS4004DS and to a power outlet

FS4008DS

The front panel of the FS4008DS consists of eight 10/100 Mbps ports, one Uplink port, and LED indicators. See Figure 2-3.

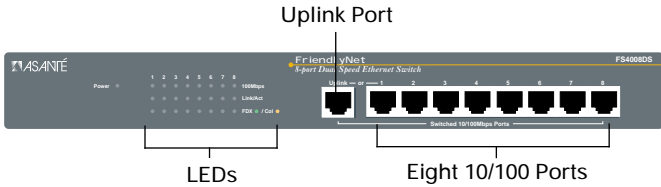

Figure 2-3 FriendlyNet FS4008DS front panel

The back panel of the FS4008DS consists of a power switch, an AC power connector, and a system fan.

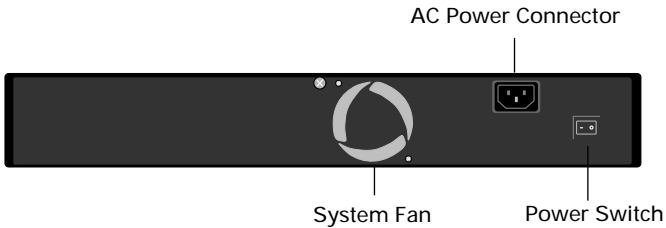

Figure 2-4 FriendlyNet FS4008DS back panel

Installation

Cabling and Voltage Requirements

This section describes the cabling and voltage requirements of the Switch.

Cabling Requirements

100Base-TX requires data-grade (Category 5) UTP (unshielded twisted-pair) cable.

- ▲ **Important!** Some installations have Category 5 cabling but do not have wall outlets and/or wiring closet punch-down blocks that meet Category 5 requirements.

100Base-TX requires that all wiring and accessories meet EIA/TIA 568B specifications for proper operation. When wiring a 100Base-TX network, make sure that the entire cable plant meets specifications.

Voltage Requirements

- ▲ **Important!** Check the AC power line voltage used in your area. The AC power adapter included with your Switch must match the power supply voltage used in your area.
 - **AC input power:** Equal to the AC power voltage used in your area

Mounting Configurations

This section describes how to mount the Switch on a desktop or a wall. It also explains how to install the Switch in an equipment rack.

Desktop Mounting

To mount the Switch on a desktop or shelf:

- 1 Attach the four rubber feet (supplied) to the bottom of each corner on the Switch. See Figure 2-5



Figure 2-5 Desktop mounting

- 2 Place the Switch on a flat, stable, horizontal desktop or shelf.
Make sure you allow enough ventilation space between the Switch and surrounding objects.
The Switch is ready for network connections.

Installation

Wall Mounting the FS4004DS

The FS4004DS comes with a wall-mount kit.

- ▲ **Important!** The FS4008DS **cannot** be mounted on a wall.

To mount the FS4004DS on a wall, consider the following when selecting a site for the FS4004DS:

- ❑ Select a site that is free of obstructions from other equipment or devices
- ❑ Place the Switch high enough to easily observe LED indicators and to allow for easy power and cable access
- ❑ Decide whether you want the Switch's front panel to face either up or down

To mount the FS4004DS on a wall:

- 1 Measure the screw holes on the bottom of the FS4004DS.
- 2 Drill two holes into the wall equalling the same distance as measured in step 1.
 - ▲ **Important!** Do not drill the holes too deep into the wall.
- 3 Insert the plastic anchors (supplied) into the drilled holes and gently tap them in with a hammer.
- 4 Insert and turn the screws (supplied) into the plastic anchors, leaving a small portion of the screws sticking out.
- 5 Lift the FS4004DS and align the slots on the bottom of the FS4004DS with the screw anchors.
- 6 Gently slide the FS4004DS onto the screws.
The FS4004DS wall mounting is complete. The FS4004DS is ready for network connections.

Rack Mounting the FS4008DS

The FS4008DS comes with a rack-mounting kit.

- ▲ **Important!** The FS4004DS **cannot** be installed in an equipment rack.

The FS4008DS can be mounted in a standard 19-inch equipment rack. This rack can be placed in a wiring closet with other equipment.

To install the FS4008DS in an equipment rack:

- 1 Attach the two mounting brackets (supplied) on each side of the FS4008DS. See Figure 2-6.

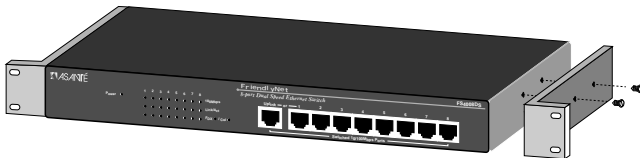

Figure 2-6 Attaching mounting brackets to the FS4008DS

- 2 Mount the FS4008DS in the equipment rack by screwing the mounting brackets to the equipment rack. See Figure 2-7.

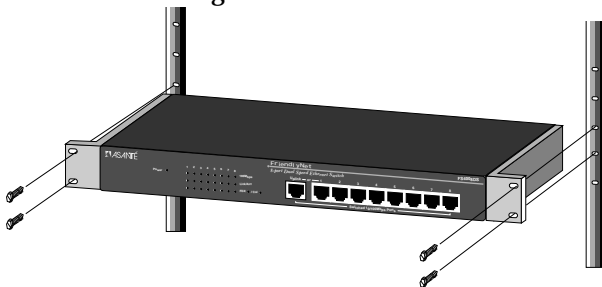

Figure 2-7 Mounting the FS4008DS in an equipment rack

The FS4008DS rack mounting is complete. The FS4008DS is ready for network connections.

Installation

Connecting Network Devices

Before you connect network devices to the Switch, review the following guidelines:

- ✓ Make sure the network cable length is **less than 100 meters**.
- ✓ Use a **straight-through** twisted pair cable or a **cross-over** cable.
- ✓ When connecting two switches together (cascading switches), make sure that the link between them is **not longer than 100 meters**.
- ✓ Network cable segments can be connected to, or disconnected from, the Switch while the Switch's power is on.

Connecting a PC to the Switch

- ❑ Use a two-pair Category 5 UTP **straight-through** cable with RJ-45 connectors.
- ❑ Connect the PC to any of the Switch's ports (1 - 4 for the FS4004DS or 1 - 8 for the FS4008DS). See Figure 2-8.

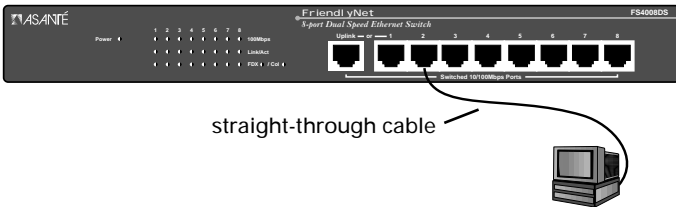

Figure 2-8 Connecting a PC to the Switch

Connecting a Hub to the Switch

- ❑ Use a two-pair Category 5 UTP **straight-through** cable with RJ-45 connectors.
- ❑ Connect the hub's **uplink** port to any of the Switch's ports (1 – 4 for the FS4004DS or 1 – 8 for the FS4008DS). See Figure 2-9.

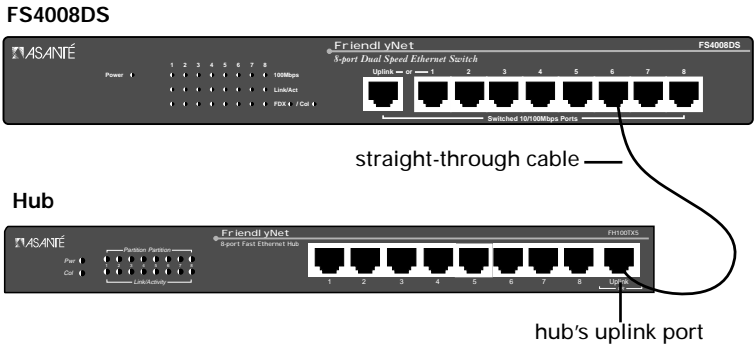

Figure 2-9 Connecting a hub to the Switch

Installation

Connecting a Hub without an Uplink Port to the Switch

If a hub is not equipped with an uplink port, connection can be made using either a straight-through cable or a cross-over cable, as outlined below.

FS4008DS switch

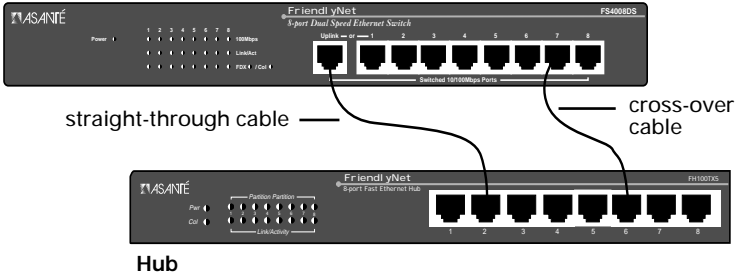

Figure 2-10 Connecting a hub without an uplink port to the Switch

Using Straight-Through Cable

- Connect the Switch's **uplink** port to any port on the hub.

Using Cross-over Cable

- Connect any of the Switch's ports (1 – 4 for the FS4004DS or 1 – 8 for the FS4008DS) to any port on the hub.

Connecting the Switch to Another Switch or Network Device

The Switch can be connected to another switch or to other network devices (such as a router, bridge, etc.) via a two-pair Category 5 UTP straight-through or cross-over cable. See Figure 2-11.

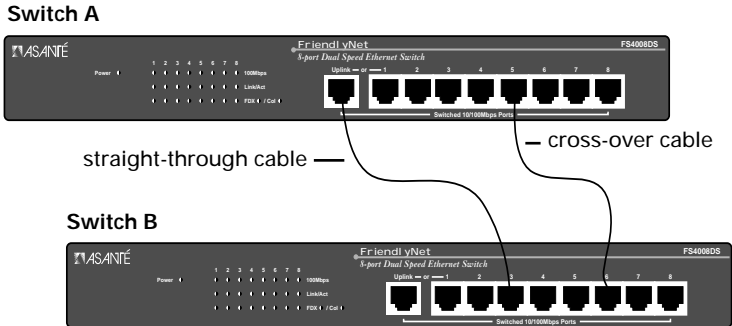

Figure 2-11 Connecting the Switch to another switch or network device

Using Straight-Through Cable

- Connect the Switch's **uplink** port to any of the other switch's/device's 10Mbps or 100Mbps ports.

Using Crossover Cable

- Connect any port on the Switch (Switch A) to any of the 10Mbps or 100Mbps ports on the other switch (switch B).

Installation

Powering on the Switch

This section describes how to power on the FS4004DS and the FS4008DS Fast Ethernet Switch.

FS4004DS

The FS4004DS's may be turned on with or without LAN segment cables connected.

To power on the FS4004DS:

- 1 Connect one end of the power cord (supplied) into the AC power connector on the FS4004DS' back panel.
- 2 Connect the power cord to a local power source outlet.

Note: There is no power switch on the FS4004DS. The FS4004DS is automatically powered on as soon as the power cord is connected to the Switch and to a power outlet.

The FS4008DS's power supply adjusts to the local power source automatically. .

FS4008DS

The FS4009DS may be turned on with or without LAN segment cables connected

To power on the FS4008DS:

- 1 Connect one end of the power cord (supplied) into the AC power connector on the FS4008DS' back panel.
- 2 Connect the power cord to a local power source outlet.
- 3 Turn the power switch to the "on" position.

The FS4008DS's power supply adjusts to the local power source automatically. .

3

LED Indicators

This chapter explains how to interpret the front-panel LED indicators on the FriendlyNet Fast Ethernet Switch.

The indicators are discussed in the following sections.

- ❑ LED indicators on the Switch
- ❑ LED indicators for power connections
- ❑ LED indicators for port connections
- ❑ LED indicators for Switch connections

LED Indicators on the Switch

The LED indicators on the Switch are used to facilitate monitoring and troubleshooting.

These LEDs are:

- ❑ Power
- ❑ Link/Act (Link/Activity)
- ❑ 100 Mbps Operation
- ❑ FDX/Col (Full-duplex/Collision)

LED Indicators

The front-panel LEDs for the FS4004DS and the FS4008DS are shown in Figure 3-1 and Figure 3-2, respectively.

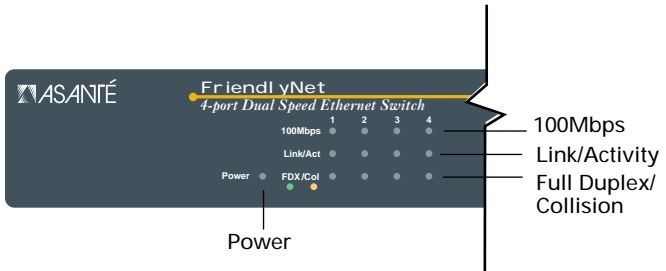

Figure 3-1 FS4004DS LEDs

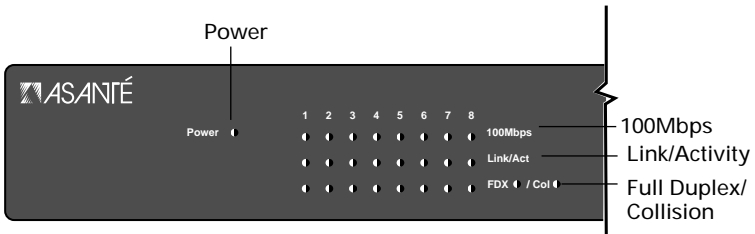

Figure 3-2 FS4008DS LEDs

LED Indicators for Power Connections

After the Switch is turned on, the LED indicators should respond as follows:

- All LED indicators blink momentarily. This represents a reset of the system.
- The FDX/Col LED indicators blink from **yellow** to **green**.
- The power LED indicator lights and remains ON. If this indicator is not lit, check to make sure that the AC power connector is properly connected in the socket and that the power switch is ON.

LED Indicators for Port Connections

Link/Activity LED

The **green** Link/Activity LED indicates if there is a device detected on the other end of the port and if there is traffic on the port.

Table 3-1 describes the possible status indications of the Link/Activity LEDs.

Table 3-1 Link/Activity LED status indicators

State	Status
On	Normal data/link pulse reception
Off	No twisted-pair cable connected Link pulse disabled at other end No power to the switch, twisted-pair connection faulty Non-100Base-TX device at other end Twisted-pair cable exceeds recommended length
Blinking	Receiving network traffic

100Mbps Operation LED

The 100Mbps Operation LED indicates if a 10Mbps or a 100Mbps device is connected to the port.

Table 3-2 describes the possible status indications of the 100Mbps Operation LED

Table 3-2 100Mbps LED status indicators

State	Status
On	A 100Mbps device is connected to a port or the uplink port
Off	A 10Mbps device is connected to a port or the uplink port

LED Indicators

FDX/Col LED

The **FDX/Col (full duplex/collision)** LED indicates when a port is in full duplex (FDX) mode, or when two or more stations on the specific network segment attempt to transmit packets simultaneously, causing a packet collision.

- Δ **Note:** This LED can display both **green** and **yellow** colors (see Table 3-1).

- Δ **Note:** Collisions are normal in Fast Ethernet networks. Excessive collisions may indicate that your network is congested.

Table 3-1 describes the possible status indications of the FDX/Col LEDs.

Table 3-1 FDX/Collision LED status indicators

State	Status
On (green)	Port is in full duplex (FDX) mode
Off	Port is in half duplex (HDX) mode
Blinking (yellow)	Two or more stations on the network are attempting to transmit packets simultaneously to the port, causing a collision

LED Indicators for Switch Connections

PC to Switch Connection

The LED indicators for PC connection are dependent on the PC's LAN card capabilities.

Table 3-2 describes the possible status indications of the PC to Switch connections:

Table 3-2 PC to Switch Connection LED Status

	100 Mbps	Link/Activity	FDX/Collision
On	Connected at 100 Mbps	PC connected	Connected at full duplex mode
Off	Connected at 10 Mbps	PC not connected	Connected at half duplex mode

Switch to Hub Connection

Table 3-3 describes the possible status indications of the Switch to Hub connection:

Table 3-3 Hub to Switch Connection LED Status

Hub Types	100Mbps	Link/Act	FDX/ Collision
10BaseT Hub	OFF	ON	OFF
100Base-T Hub	ON	ON	OFF

LED Indicators

Switch to Switch or other Network Devices Connection

Table 3-4 describes the possible status indications of the Switch to switch or other network devices connection.

Table 3-4 Switch to Switch Connection LED Status

Cable Types	100Mbps	Link/Act	FDX/ Collision
Straight Cable	ON - 100Mbps OFF - 10Mbps	ON	Depends on the con- nected switch or other devices
Crossover Cable	ON - 100Mbps OFF - 10Mbps	ON	Depends on the con- nected switch or other devices

A

Troubleshooting

Table A-1 describes how to troubleshoot problems with your network and/or the Switch by monitoring the Switch's LEDs.

Table A-1 Troubleshooting

Problem	Action
Power LED is off	<ul style="list-style-type: none">✓ Make sure the power adapter is connected to the power outlet and is properly inserted into the power connector on the switch.✓ Determine if the power outlet is functional by plugging another device into the receptacle.
Collision LED is blinking constantly	<p>Collisions are normal in Fast Ethernet networks; however, excessive collisions may indicate that your network is overly congested.</p> <ul style="list-style-type: none">✓ Make sure the workstation cables do not exceed the maximum length of 100 meters.✓ Make sure the workstation cables meet EIA/TIA 568B specifications for Category 5 wiring.✓ Make sure the total network diameter does not exceed the maximum distance.✓ Make sure there are no faulty Fast Ethernet adapters or other equipment on the network.

Troubleshooting

Problem	Action
Link LED is off	<ul style="list-style-type: none">✓ Make sure the switch is powered on.✓ Make sure the device on the other end is powered on.✓ Make sure the proper cabling is used between the device and the Switch (refer to the cable guidelines specified in Chapter 2).✓ Make sure the correct cable is properly connected to the Switch and the network device.✓ Make sure the cable does not exceed recommended length (100 meters).
Slow performance	<ul style="list-style-type: none">✓ Make sure the duplex mode on both ends of the link connection is configured to the same mode (half or full duplex).✓ If your adapter card supports NWay auto-negotiation, make sure the driver also supports full duplex mode.

B

Specifications

FS4004DS and FS4008DS Specifications

Standards	<ul style="list-style-type: none"><input type="checkbox"/> IEEE 802.3 10Base-T Ethernet<input type="checkbox"/> IEEE 802.3u 100Base-TX Fast Ethernet<input type="checkbox"/> IEEE 802.3 frame types: transparent<input type="checkbox"/> IEEE 802.3 MAC layer frame size: 64 to 1518 bytes
Protocol	CSMA/CD
Data Transfer Rate	Ethernet: Fast Ethernet 10Mbps (half duplex): 100Mbps (half duplex) 20Mbps (full duplex): 200Mbps (full duplex)
Topology	Star
Network Cables	10Base-T: <ul style="list-style-type: none"><input type="checkbox"/> 2-pair UTP Category 5 (100m maximum) 100Base-TX: <ul style="list-style-type: none"><input type="checkbox"/> 2-pair UTP Category 5 (100m maximum)
Number of Ports	FS4004DS: 4 x 10/100 Mbps ports FS4008DS: 8 x 10/100 Mbps ports

Specifications

FS4004DS and FS4008DS Specifications

Media Interface Exchange	MDI-II RJ-45 shared with port 1x
---------------------------------	----------------------------------

Physical and Environmental

AC Inputs	100 - 240 VAC, 50/60 Hz (internal universal power supply)
------------------	---

Power Consumption	40 watts maximum
--------------------------	------------------

Operating Temperature	32° – 122° F (0° - 50° C)
------------------------------	---------------------------

Storage Temperature	-22° – 140° F (-30° – 60° C)
----------------------------	------------------------------

Humidity	5% to 95% non-condensing
-----------------	--------------------------

Dimensions	FS4004DS: 232 x 142 x 43 mm (1U) FS4008DS: 324 x 231 x 43 mm (1U)
-------------------	--

Weight	FS4004DS: 1.2Kg FS4008DS: 2.5Kg
---------------	------------------------------------

EMI	FCC Class A, CE Mark, VCCI Class I
------------	------------------------------------

Safety	UL (UL 1950), CSA (CSA950)
---------------	----------------------------

FS4004DS and FS4008DS Specifications

Performance

Transmission Method	Store-and-forward
RAM Buffer	FS4004DS: 4MB per device FS4008DS: 8MB per device
Filtering Address Table	8K entries per device
Packet Filtering/ Forwarding Rate	148,800 pps per port (for 100 Mbps)



Technical Support

Contacting Technical Support

To contact Asanté Technical Support:

Telephone	(800) 622-7464
Fax	(408) 432-6018
Fax-Back	(800) 741-8607
Internet Mail	support@asante.com
World Wide Web Site	http://www.asante.com
Bulletin Board Service (BBS)	(408) 432-1416
ARA BBS (guest log-in)	(408) 894-0765
AppleLink Mail/BBS	ASANTE
FTP Archive	ftp.asante.com

Technical Support Hours

6:00 a.m. to 5:00 p.m. Pacific Standard Time USA, Monday - Friday.

Index

Numerics

- 100Base-TX, cables supported B-1
- 100Mbps LED 3-3
- 10Base-T, cables supported B-1
- 10Mbps LED 3-3

A

- about this manual v
- AC
 - inputs B-2
 - power connector 2-3
- activity LED 3-3
- address
 - entry table, MAC 1-3
 - table, filtering B-3
- assistance. *See* technical support
- auto-negotiation 1-3

B

- bridge vs. switch 1-4
- buffer
 - packet 1-3
 - RAM B-3

C

- cabling requirements 2-4
- category 5 cable 2-4
- chapter contents v
- collisions
 - LED 3-4
 - troubleshooting A-1
- CSMA/CD B-1

D

- data
 - filtering rate 1-3
 - forwarding rate 1-3
 - transfer rate B-1
- desktop mounting 2-5
- devices, connecting 2-8 – 2-11
- dimensions B-2
- document conventions vi
- duplex mode, troubleshooting A-2

E

- EMI B-2
- equipment rack installation 2-7
- expansion, network 1-4

F

- fast ethernet
 - features of 1-3
 - overview 1-3
 - switch. *See* FS4008DS or FS4004DS
- FDX/collision LED 3-4
- features 1-2
 - performance 1-3
- filtering
 - address table B-3
 - rate, data 1-3
 - /forwarding rate, packet B-3
 - forwarding rate, data 1-3
- FriendlyNet switch. *See* FS4004DS or FS4008DS
- front panel LEDs, overview 3-1
- FS4004DS
 - back panel 2-2
 - components 2-2
 - features 1-2
 - front panel 2-2
 - LEDs
 - diagram 3-2
 - overview 3-1
 - mounting options 2-5
 - overview 1-1
 - performance features 1-3
 - power, connecting 2-12
 - specifications B-1
 - wall mounting 2-6
- FS4008DS
 - back panel 2-3
 - components 2-3
 - equipment rack installation 2-7
 - features 1-2
 - front panel 2-3
 - LEDs
 - diagram 3-2
 - overview 3-1

- FS4008DS (continued)
 - mounting options 2-5
 - overview 1-1
 - performance features 1-3
 - power, connecting 2-12
 - specifications B-1
- full duplex
 - LED 3-4
 - troubleshooting A-2
- H**
- help. *See* technical support or troubleshooting
- hub
 - connecting to switch 2-9, 2-10
 - to switch, LED 3-5
- humidity B-2
- I**
- IEEE 802.3 B-1
- installation 2-1
 - cabling requirements 2-4
 - devices, connecting
 - hub to switch 2-9, 2-10
 - PC to switch 2-8
 - switch to switch 2-11
 - network devices, connecting 2-8
 - package contents 2-1
 - powering on 2-12
 - voltage requirements 2-4
- installation
 - desktop mounting 2-5
 - equipment rack installation 2-7
 - mounting options 2-5
 - wall mounting 2-6
- L**
- LEDs
 - collision
 - description 3-4
 - troubleshooting A-1
 - duplex
 - description 3-4
 - troubleshooting A-2
- LEDs (continued)
 - link/activity
 - description 3-3
 - troubleshooting A-2
 - overview 3-1
 - PC to switch connection 3-5
 - power
 - troubleshooting A-1
 - connections 3-2
 - switch
 - to hub connection 3-5
 - to switch connection 3-6
- link
 - LED 3-3
 - troubleshooting A-2
- M**
- MAC address entry table 1-3
- manual
 - about v
 - chapter contents v
 - document conventions vi
- media interface exchange B-2
- mounting options 2-5
 - desktop 2-5
 - equipment rack 2-7
 - wall 2-6
- N**
- network
 - cables supported B-1
 - devices
 - connecting 2-8
 - guidelines 2-8
 - expansion 1-4
 - segments, defined 1-4
- O**
- operating temperature B-2
- overview v, vi
 - fast ethernet 1-3
 - installation 2-1
 - manual v
 - switch 1-1
 - switching technology 1-3

P

- package contents 2-1
- packet
 - buffer 1-3
 - filtering/forwarding rate B-3
- PC (personal computer)
 - connecting to switch 2-8
 - to switch, LED 3-5
- performance
 - features 1-3
 - troubleshooting A-2
- personal computer (PC), connecting
 - to switch 2-8
- port
 - 100Mbps LED 3-3
 - 10Mbps LED 3-3
 - activity LEDs 3-3
 - connection LEDs 3-4
 - link LEDs 3-3
- power
 - connecting 2-12
 - connector 2-3
 - consumption B-2
 - LEDs 3-2
 - troubleshooting A-1
- problems, determining A-1
- product overview 1-1
- protocol, supported B-1

R

- rack, equipment, installation 2-7
- RAM buffer B-3
- requirements
 - cabling 2-4
 - voltage 2-4

S

- safety specifications B-2
- segments, network, defined 1-4
- specifications B-1
- standards, supported B-1
- storage temperature B-2
- store-and-forward switching
 - scheme 1-3
- support, technical C-1

switch

- connecting to another switch 2-11
- defined 1-4
- to switch, LED 3-6
- vs. bridge 1-4
- See also* FS4008DS or FS4004DS
- switching
 - overview 1-3
 - scheme 1-3
 - technology, overview 1-4
- system fan 2-3

T

- table
 - filtering address B-3
 - MAC address entry 1-3
- technical
 - specifications B-1
 - support C-1
- temperature
 - operating B-2
 - storage B-2
- topology supported B-1
- transmission method B-3
- troubleshooting A-1

U

- UTP (unshielded twisted-pair)
 - cable 2-4

V

- voltage requirements 2-4

W

- wall mounting 2-6
- weight B-2



ASANTÉ TECHNOLOGIES, INC., 821 FOX LANE, SAN JOSE, CA 95131

PHONE: 408.435.8388, 800.662.9686 • FAX: 408.432.7511 • e-mail address: sales@asante.com •
World Wide Web site: <http://www.asante.com>

©1997 Asanté Technologies Inc., Asanté is a trademark of Asanté Technologies, Inc.
All brand names and products are trademarks or registered trademarks of their respective holders.

September 1997

Part Number 06-00384-00 Rev.A