

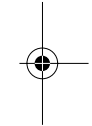

NetStacker II

Dual Speed Stackable Hub

User's Manual

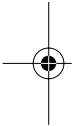



Copyright Notice

Trademarks

Asanté Technologies and FriendlyNET are trademarks of Asanté Technologies, Inc. Ethernet is a registered trademark of the Xerox Corporation. All brand names and products are trademarks or registered trademarks of their respective holders.

FCC Information

This device complies with part 15 of the FCC Rules. Operation is subject to the following two conditions: (1) this device may not cause harmful interference and (2) this device must accept any interference received, including interference that may cause undesired operation.

Operation of this equipment in a residential area is likely to cause interference, in which case, the user, at his or her own risk and expense, will be required to correct the interference.

FIVE YEAR LIMITED WARRANTY

Subject to the limitations and exclusions below, Asanté warrants to the original end user purchaser that the covered products will be free from defects in materials and manufacturing workmanship for a period of 5 years from date of purchase. This warranty excludes fans, power supplies and accessories. Asanté warrants that the fans and power supplies contained in covered products will be free from defects in materials and manufacturing workmanship for one year from date of purchase.

To take advantage of this warranty, you must:

(1) contact Asanté for a return materials authorization (RMA) number. The RMA number must be clearly written on the outside of the returned package. (2) Product must be sent to Asanté postage paid. (3) Provide Asanté with proof of the original date of purchase.

During the warranty period, Asanté's sole obligation, and your exclusive remedy is that Asanté will repair or replace defective product or components with new, refurbished or equivalent product or components as deemed appropriate by Asanté in its sole discretion. The foregoing is your exclusive remedy, and Asanté's only warranty obligation.

Asanté makes no warranty with respect to accessories (including but not limited to cables, brackets and fasteners) included with the covered product. No warranty is made as to any discontinued product, which is defined as product purchased more than thirty days after Asanté has removed such product from its price list or discontinued shipments of such product.

This warranty is exclusive and is limited to the original end-user purchaser only. This warranty shall not apply to secondhand products or to products that have been modified or subjected to abuse, misuse, abnormal electrical or environmental conditions, or any condition other than what can be considered normal use.

ASANTÉ MAKES NO OTHER WARRANTIES, EXPRESS, IMPLIED OR OTHERWISE, REGARDING THE ASANTÉ PRODUCTS. EXCEPT TO THE EXTENT SPECIFICALLY MANDATED BY APPLICABLE LAW, ALL WARRANTIES OR CONDITIONS OF MERCHANTABILITY OR FITNESS FOR A PARTICULAR PURPOSE ARE HEREBY DISCLAIMED.

ASANTÉ'S LIABILITY ARISING FROM OR RELATING TO THE PURCHASE, USE OR INABILITY TO USE THE PRODUCTS IS LIMITED TO REPAIR, REPLACEMENT OR A REFUND OF THE PURCHASE PRICE PAID. IN NO EVENT SHALL ASANTÉ BE LIABLE FOR INDIRECT, SPECIAL, INCIDENTAL, OR CONSEQUENTIAL DAMAGES OF ANY KIND OR CHARACTER FOR THE BREACH OF ANY EXPRESS OR IMPLIED WARRANTY, INCLUDING ECONOMIC LOSS, DAMAGE TO PROPERTY AND, TO THE EXTENT PERMITTED BY LAW, DAMAGES FOR PERSONAL INJURY, HOWEVER CAUSED AND ON ANY THEORY OF LIABILITY (INCLUDING NEGLIGENCE). THESE LIMITATIONS SHALL APPLY EVEN IF ASANTÉ HAS BEEN ADVISED OF THE POSSIBILITY OF SUCH DAMAGES OR IF THIS WARRANTY OR ANY CLAUSE HEREIN IS FOUND TO FAIL OF ITS ESSENTIAL PURPOSE.

YOU MUST COMPLETE AND RETURN THE WARRANTY REGISTRATION CARD WITHIN 30 DAYS OF YOUR PURCHASE TO PRESERVE WARRANTY BENEFITS.

Some jurisdictions do not allow the exclusion or limitation of incidental or consequential damages or limitations on how long an implied warranty lasts, so the above limitations or exclusions may not apply to you. This warranty gives you specific legal rights, and you may have other rights, which vary from jurisdiction to jurisdiction.

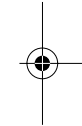
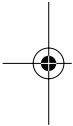
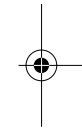



Table of Contents

About This Manual	iii
Chapter Contents	iii
Document Conventions	iv
Important Safety Instructions	iv
Introduction	1-1
Package Contents	1-1
The NetStacker II Hubs	1-1
Performance Features	1-3
Installation	2-1
Components	2-1
Front Panels of 12 Port and 24 Port Hubs	2-1
Rear Panels of 12 Port and 24 Port Hubs	2-3
Cabling and Voltage Requirements	2-4
Cabling Requirements	2-4
Voltage Requirements	2-4
Placement and Mounting	2-5
Hub Location	2-5
Desktop Mounting	2-5
Rack Mounting	2-5
Connecting Network Devices	2-6
Connecting Workstations or Servers	2-6
Connecting to Another Hub	2-7
Stacking Hubs	2-10
Powering on the Hub	2-11





LED Indicators 3-1

 Power LED 3-2

 Collision Indicator LEDs 3-2

 Hub ID Number LEDs 3-3

 Port Link Activity Indicator LEDs 3-3

 10Mbps Link Activity LEDs 3-3

 100Mbps Link Activity LEDs 3-3

Troubleshooting A-1

Specifications B-1

Technical Support C-1

 Contacting Technical Support C-1

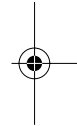
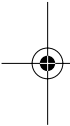



About This Manual

This manual describes the NetStacker II dual speed stackable hubs. The manual focuses on the following two models:

- 12-port 10/100Mbps managed stackable hub
- 24-port 10/100Mbps managed stackable hub

Unless otherwise noted, all information provided in this manual is applicable to both units.

Chapter Contents

This manual is divided into the following chapters and appendices:

- Chapter 1, "Introduction," provides an overview of the NetStacker II dual speed stackable hubs and their features
- Chapter 2, "Installation," describes the components and explains how to install, mount, and apply power to the NetStacker II dual speed stackable hubs
- Chapter 3, "LED Indicators," describes how to interpret the LEDs on the NetStacker II dual speed stackable hubs
- Appendix A, "Troubleshooting," explains how to solve problems by monitoring the LEDs on the NetStacker II dual speed stackable hubs
- Appendix B, "Specifications," describes the NetStacker II dual speed stackable hubs' technical specifications
- Appendix C, "Technical Support" explains how to contact Asanté Technical Support

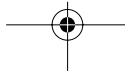
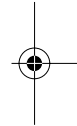
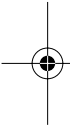



Document Conventions

This manual uses the term “NetStacker II” to refer to the 12 port and 24 port dual speed hubs, and “hub” to refer to all other Ethernet hubs.

This manual uses the following conventions to convey instructions and information:

- ◆ *Note:* Noteworthy information, which contains helpful suggestions or references to other sections in the manual, is in this format.
- ▲ **Important!** Significant information that calls attention to important features or instructions is in this format.

Important Safety Instructions

1. Read all of these instructions.
2. Save these instructions for later use.
3. Follow all warnings and instructions marked on the product.
4. Unplug this product from the wall outlet before cleaning. Do not use liquid cleaners or aerosol cleaners. Use a damp cloth for cleaning.
5. Do not use this product near water.
6. Do not place this product on an unstable cart, stand, or table. The product may fall, causing serious damage to the product.
7. The openings should never be blocked by placing the product on a bed, sofa, rug, or other similar surface. This product should never be placed near or over a radiator or heat register. This product should not be placed in a built-in installation unless proper ventilation is provided.
8. This product should be operated from the type of power source indicated on the marking label. If you are not sure of the type of power available, consult your dealer or local power company.
9. This product is equipped with a three-wire grounding type plug, a plug having a third (grounding) pin. This plug will only fit into a grounding type power outlet. This is a safety feature. If you are unable to insert the plug into the outlet, contact your electrician to replace your obsolete outlet. Do not defeat the purpose of the grounding type plug.
10. Do not allow anything to rest on the power cord. Do not locate this product where persons will walk on the cord.

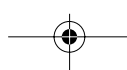
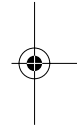
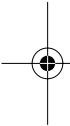



About This Manual

11. If an extension cord is used with this product, make sure that the total ampere ratings on the products connected to the extension cord do not exceed the extension cord ampere rating. Also make sure that the total of all products plugged into the wall outlet does not exceed 15 amperes.
12. Never push objects of any kind into this product through cabinet slots as they may touch dangerous voltage points or short out parts that could result in a risk of fire or electric shock. Never spill liquid of any kind on the product.
13. Do not attempt to service this product yourself, as opening or removing covers may expose you to dangerous voltage points or other risks. Refer all servicing to service personnel.

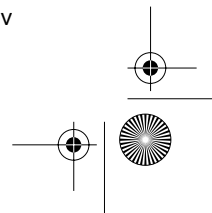
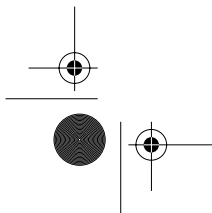
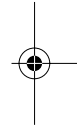
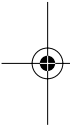

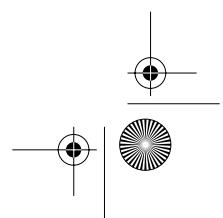
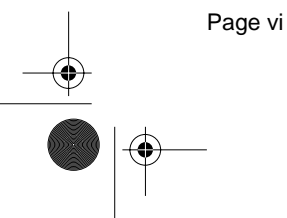
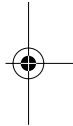
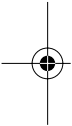
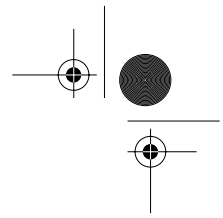
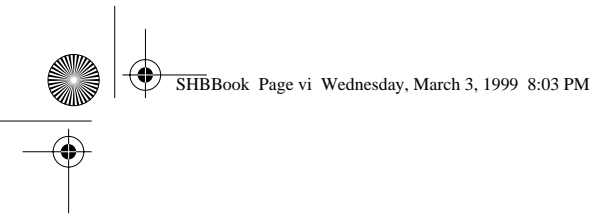

1

Introduction

This chapter introduces the Asanté NetStacker II 12 port and 24 port dual speed stackable hubs and provides an overview of basic hub technology. The chapter is made up of the following sections:

- Package Contents
- The NetStacker II Hubs
- Performance Features
- Network Concepts

Package Contents

The package contains the following items:

- (1) NetStacker II 12 port hub, or NetStacker II 24 port hub
- (1) AC power cord
- (4) Self-adhesive rubber feet
- (1) Rack-mount kit, which includes two rack-mounting brackets and mounting screws
- User's Manual (this book)

The NetStacker II Hubs

Thank you for purchasing an Asanté NetStacker II 12 port or 24 port hub. The NetStacker II products are unmanaged dual speed stackable hubs which provide a compact, flexible solution for medium to large workgroups and small office LANS. These 12-port and 24-port hubs comply fully with IEEE802.3 and IEEE802.3u standards.

Both the 12-port and 24-port hubs can be upgraded easily to managed hubs by addition of an optional plug-in management module. This module slides into a slot on the back panel of the hub. You do not need to purchase another hub to gain full management capabilities - you can convert your unmanaged hub in a matter of minutes.

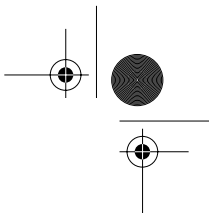
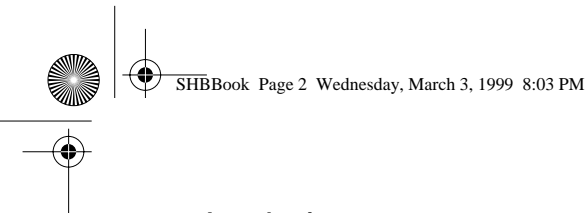

Introduction

The NetStacker II 12 port unmanaged hub provides 12 twisted pair ports. The 24 port managed hub provides 24 twisted pair ports. In addition, both hubs offer an expansion slot for a 100Base-FX interface so the user can slide a fiber-optic module into the rear panel. A slot for a 100Base-FX interface is also provided on the front panel, for use when the management module has been installed in the rear panel slot.

Both hubs automatically detect the speed (10Mbps or 100Mbps) of the devices they are connected to. For additional expansion, each hub provides an Uplink push-button for the 12th port, which can be cascaded to another hub by means of straight through cable.

The NetStacker II hubs can be stacked up to 8 units high and connected by means of the "Stack Connection In" and "Stack Connection Out" ports on the rear panel. In addition, one of the hubs in the stack may be equipped with a slide-in management module. The entire stack requires only one managed hub for all of the stacked devices to be managed. Each dual speed hub has its own ID, which is auto-detected and auto-configured. You do not have to configure the hub ID yourself.

Either model hub can be placed on a tabletop or rack mounted. With unmatched flexibility, the hubs ensure operation in any LAN environment, regardless of size. The hubs provide the solutions that users require for their complex networks.

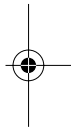
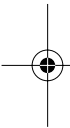

Figure 1-1 NetStacker II 12 port hub front panel

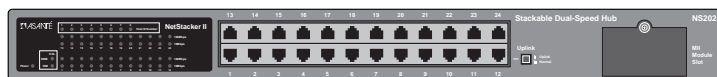
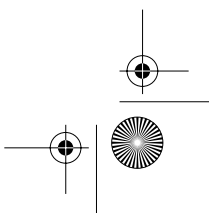
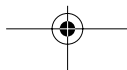
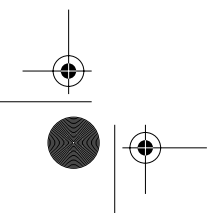
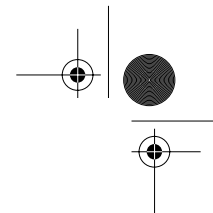
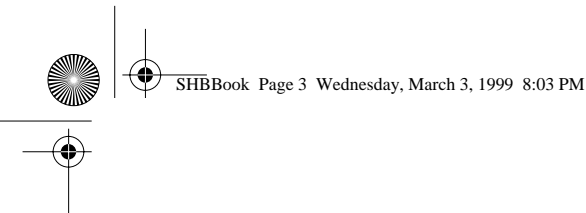

Figure 1-2 NetStacker II 24 port hub front panel





Performance Features

Each hub features full plug-and-play installation. LED indicators include power status, port link activity status, collision detection, and hub identification, for easy monitoring of hub operation.

Performance Features

The NetStacker II dual speed stackable hubs offer the following features:

- Full compliance with the IEEE802.3 and IEEE802.3u Ethernet standards
- 12 or 24 10/100Mbps auto-sensing ports
- Both 12-port and 24-port hubs stackable up to eight units
- Up to eight 12-port or 24-port hubs stackable with management by means of a single slide-in management module added to one hub
- Both models accept optional slide-in fiber optic module
- Global LEDs: power indicator, 10Mbps collision detection, 100Mbps collision detection, and 8 hub identification indicators
- Port LEDs: link activity LED for both 10Mbps and 100Mbps
- Automatic partitioning of faulty ports
- Segmented hub to reduce collisions
- 19 inch rack-mountable size
- CE mark certification
- Internal power that supports universal input voltage

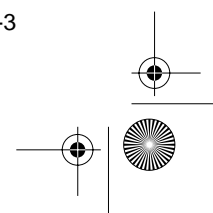
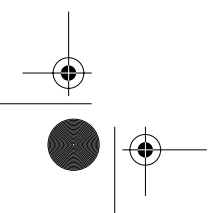
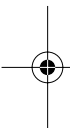

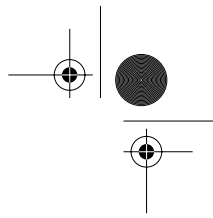
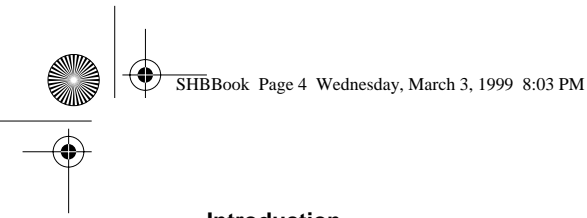

Introduction

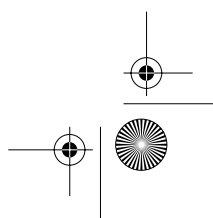
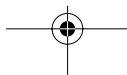
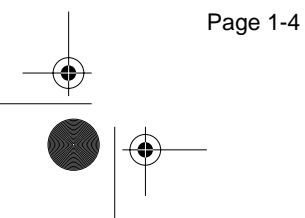
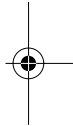
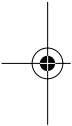

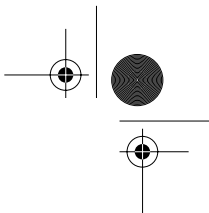

2 Installation

This chapter describes the components and explains how to install, mount, and apply power to your NetStacker II dual speed hub. It contains the following sections:

- Components
- Cabling and Voltage Requirements
- Placement and Mounting
- Connecting Network Devices
- Powering on the Hub

Components

This section describes the front and back panel layouts of the NetStacker II dual speed hubs.

Front Panels of the 12 Port and 24 Port Hubs

The front panel of the 12 port hub displays:

- Twelve dual speed (UTP) Ethernet ports
- One uplink switch button
- LED indicators.

These features are shown in Figure 2-1.



Figure 2-1 NetStacker II 12 port front panel

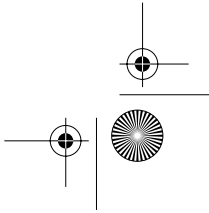
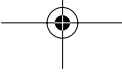
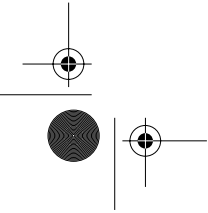

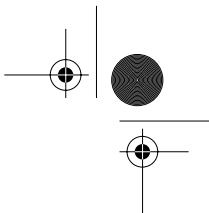
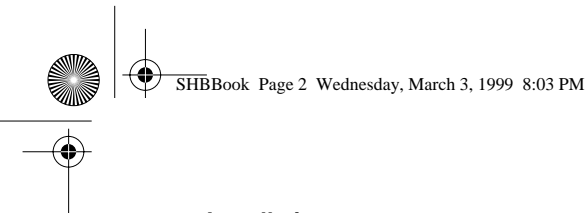

Installation

The front panel of the 24 port hub displays:

- Twenty-four dual speed (UTP) Ethernet ports
- One uplink switch button
- LED indicators.

These features are shown in Figure 2-2.

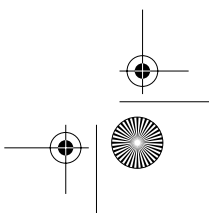
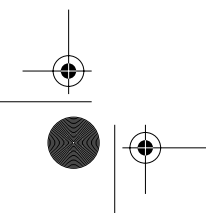
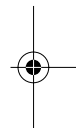
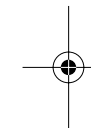

Figure 2-2 NetStacker II 24 port front panel

LED Indicators

The front panels of the NetStacker II dual speed hubs display LED indicators, as shown in Figure 2-3. The LED nomenclature, color, and function are as follows:

- Power (green): Illuminates when AC power is applied to the hub.
- Collision "COL" (amber): A collision occurs when two or more stations in the Ethernet network attempt to transmit data at the same time. The LED flashes to indicate a collision while the stations retransmit. There is one LED for 10Mbps and one for 100Mbps.
- Hub ID Number (green): Indicates the ID of the hub if it is part of a stack; this identifying number is auto-configured, from one to eight.
- Link Activity "100Mbps/10Mbps" (green): Indicates that a device is connected to the port number, and that either a 10Mbps (lower LED) or 100Mbps (upper LED) link is detected. If the link is detected, the LED turns on. If data is transmitting, the LED blinks.



Components

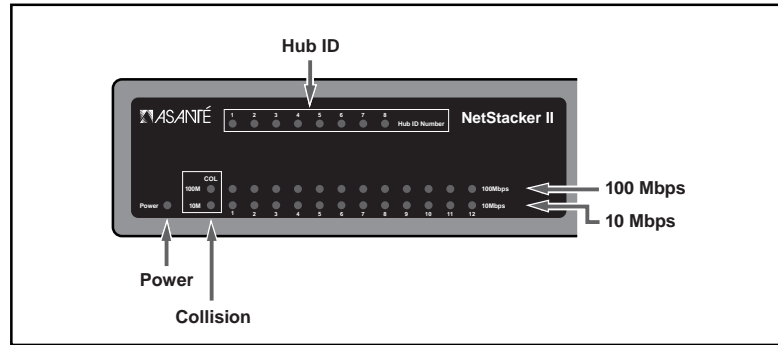

Figure 2-3 LED Indicators on 12 port hub

Rear Panels of the 12 Port and 24 Port Hubs

The rear panels of the 12 port and 24 port hubs both display:

- Management Module Slot; can also be used for optional 100Base FX slide-in module that allows connection to fiber optic network media
- Stack Connection In and Stack Connection Out: Used to join the hubs in a stack with stacking cables (one provided per hub). Up to eight hubs may be connected together within a collision domain.
- Fan vents
- AC Power socket
- Power switch

These features are shown in Figure 2-4.



Figure 2-4 NetStacker II rear panel

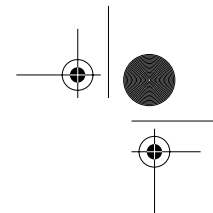
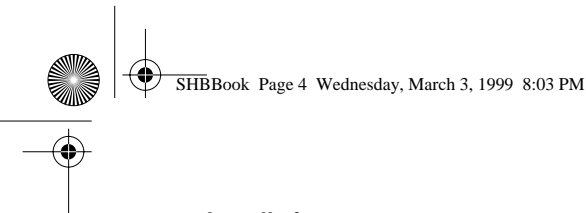

Installation

Cabling and Voltage Requirements

This section describes the cabling and voltage requirements for the NetStacker II 12 port and 24 port hubs.

- ◆ **Note:** You may connect network cable segments to the hub or disconnect them while the power is on. Plugging in or removing cables while your hub is running will not interrupt the traffic or disrupt the operation of the hub.

Cabling Requirements

The cabling for connections to the NetStacker II hubs must meet or exceed the following standards:

10Base-T

10Base-T transmission connection requires UTP (Unshielded Twisted Pair) Category 3 cables, not to exceed 100 meters in length.

100Base-TX

100Base-TX transmission requires UTP (Unshielded Twisted Pair) Category 5 cables, not to exceed 100 meters in length. 100Base-TX requires that all wiring and accessories meet EIA/TIA 568B specifications for proper operation. When wiring a 100Base-TX network, make sure that the *entire* cable plant meets these specifications.

- ▲ **Important:** Some installations have UTP Category 5 cabling but do not have wall outlets and/or wiring closet punchdown blocks that meet Category 5 requirements.

100Base-FX

100Base-FX transmission requires 62.5/125 micron graded-index multimode fiber-optic cable with an SC connector. For details on inserting a 100Base-FX module, see "Adding Fiber Optic Connectivity via MII" on page 11 in this chapter.

Voltage Requirements

Voltage requirements are the same for both hubs: 100 to 240VAC, at 50 to 60Hz, with a 1.2A maximum.

- ▲ **Important:** Check the AC power line voltage used in your area.

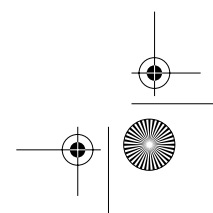
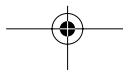
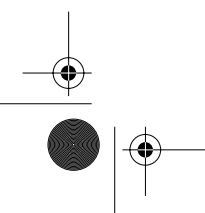
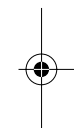
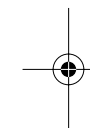



Placement and Mounting

Placement and Mounting

This section describes how to mount the NetStacker II on a desktop or shelf.

Hub Location

The location chosen for the NetStacker II hub should be less than 100 meters from servers, workstations, and other devices.

- ▲ **Important:** Category 5 cables are environment-sensitive. Make sure that the cable route is not too close to electromagnetic noise sources such as power lines or fluorescent lights.

Desktop Mounting

To place the hub on a desktop or shelf:

- 1 Attach the four rubber feet (supplied) to the bottom of each corner on the hub. See Figure 2-5.

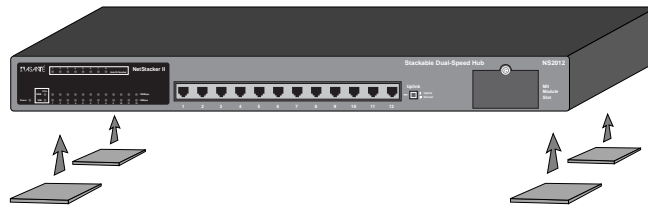

Figure 2-5 Desktop mounting

- 2 Place the hub on a flat, stable, horizontal desktop or shelf. Make sure you allow enough ventilation space between the hub and surrounding objects.

Rack Mounting

A rack mount bracket is an optional way to mount hubs in standard EIA 19-inch racks.

- 1 Align the mounting brackets on the sides of the unit with the slit over the holes as shown in Figure 2-6.
- 2 Secure the screws tightly to fix the brackets to the device.

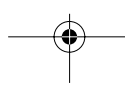

Installation

- 3 Place the device into the 19-inch rack and attach it firmly. Ensure that the ventilation holes do not get blocked.



Figure 2-6 Rack mounting

Connecting Network Devices

The Auto-sensing capability of the NetStacker II hub allows you to connect 10Mbps and/or 100Mbps devices.

Connecting Workstations or Servers

To connect your hub to workstations, servers, or other nodes:

- 1 Be sure each computer has either a 10Base-T or 100Base-TX Ethernet Network Interface Card (NIC) installed
- 2 Connect one end of the UTP cable to the RJ-45 port of the Ethernet card in each computer as shown in Figure 2-7.
 - for 10Base-T use UTP Category 3 cable or better
 - for 100Base-TX use UTP Category 5 cable or better
- 3 Plug the other end of the cable into one of the RJ-45 ports on the hub, as shown in Figure 2-7.

Connecting Network Devices

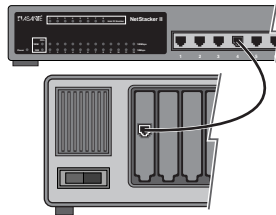

Figure 2-7 Connecting cable to a NIC

◆ *Note:* The maximum length of a cable between a hub and a device is 100 meters, including all patch cables and cross-connect wires.

- 4 Continue connecting workstations, servers, or other devices to the hub using UTP cables to create a network as shown in the example in Figure 2-8.

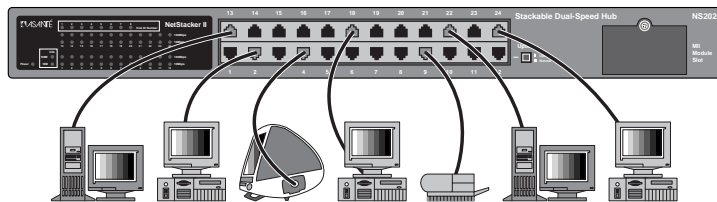

Figure 2-8 Connecting network devices

Connecting to Another Hub

To connect the NetStacker II hub to a switching hub or a repeater hub, take the following steps.

- 1 Choose the appropriate cable depending on which port you want to connect to on the NetStacker II hub. See Table 2-1 to determine which cable and uplink button setting you need to use.



Installation

- 2 Make sure that the length of the straight through cable between the NetStacker II and a 100Mbps repeater does not exceed 5 meters, including all patch cables and cross connect wires. The cable between the NetStacker II and any switch or any 10Mbps repeater cannot exceed 100 meters.
 - ◆ *Note.* If you need to connect more than 2 hubs via 100Mbps connections, you must have a switch separating the additional hubs.
- 3 Connect one end of the cable to the selected RJ-45 port of the NetStacker II hub.
- 4 Connect the other end of the cable to the selected RJ-45 port of the other hub. A connection from the Uplink Port (Port 12) to a non-uplink Port on another hub is shown in Figure 2-9.
- 5 Press the Uplink button in if your connection type and cable require it. See Table 2-1 for Uplink button settings.

Connecting:	Cable	Uplink Button
From Uplink Port (Port 12) To non-uplink port	Straight through	Press in
From Uplink Port (Port 12) To non-uplink port	Cross-over	Do not press in
From Uplink Port (Port 12) To Uplink Port on other hub	Straight through	Press in ONE, not both
From Uplink Port (Port 12) To Uplink Port on other hub	Cross-over	Do not press in either button
From non-uplink Port To non-uplink Port	Cross-over ONLY	Do not press in
From non-uplink Port To Uplink Port on other hub	Straight through	Press in button on OTHER hub
From non-uplink Port To Uplink Port on other hub	Cross-over	Do not press in either button

Table 2-1 Connecting cables and uplink button settings



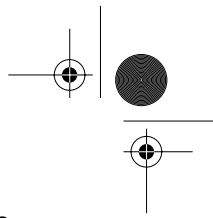

Connecting Network Devices

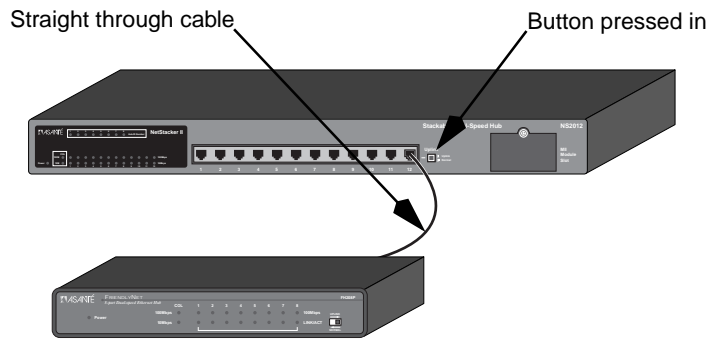
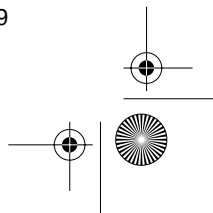
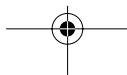
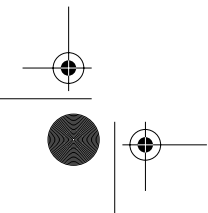
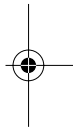
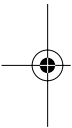

Figure 2-9 Connecting to another hub using Uplink Port





Installation

Stacking Hubs

Up to eight NetStacker II hubs may be connected within a stack. Furthermore, a management module can be installed easily in any of the stacked hubs, so that all of them can be managed. The management module communicates with a manager console by means of SNMP agent software, installed in the managed hub. This reduces considerably the expense of equipping each hub for management.

It is not necessary to configure a Hub ID for each NetStacker II hub in a stack. The auto-configure feature takes care of this for you.

- 1 Check the 50-pin "stacking" cable that was included in the package with your NetStacker II hub. It is designed specifically for stacking your unit with others of the same design.
 - ◆ *Note.* Do not use any cable but the NetStacker II stacking cable supplied with your unit; if you need additional cables, contact Asanté support.
- 2 Place the hubs in a stack so the rear panels are aligned as shown in Figure 2-10.
- 3 Connect the "Stack Connection Out" on the upper hub with the "Stack Connection In" of the hub below it. Leave the "Stack Connection In" of the uppermost hub and the "Stack Connection Out" of the lowermost hub unconnected, as shown in Figure 2-10.

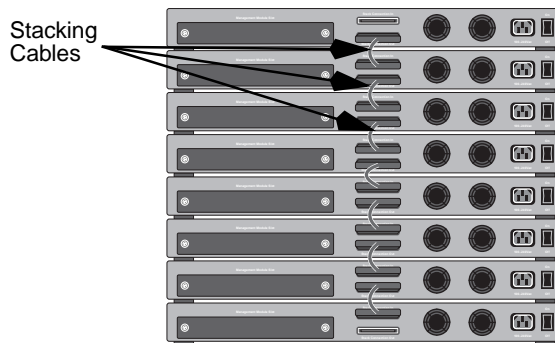
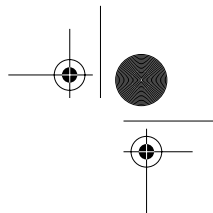
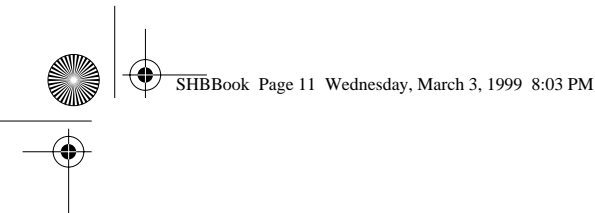

Figure 2-10 Stacking NetStacker II hubs



Connecting Network Devices

Adding Fiber Optic Connectivity via MII

To add connectivity for 100Base-FX transmission media, insert the optional MII fiber-optic module in the MII Module Slot in the back panel of the hub, as shown in Figure 2-11. If you have not installed a management module, this slot will be available for the fiber-optic connection module.

The MII Module Slot in the front panel of the hub is reserved for use when there is a management module installed in the Management Module Slot on the rear panel. For information on the use of this slot, see the Management Module manual.

- ◆ *Note:* Do not use the MII Module Slot on the front panel to install a fiber-optic module *unless* you have installed a management module in the rear panel.

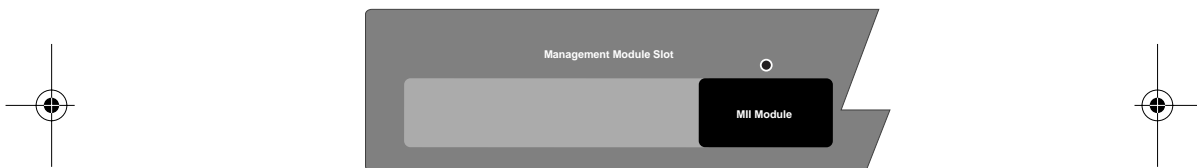
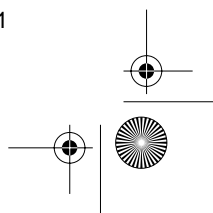
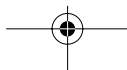
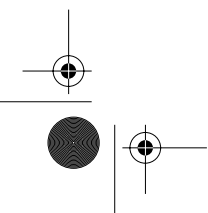
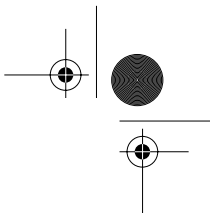
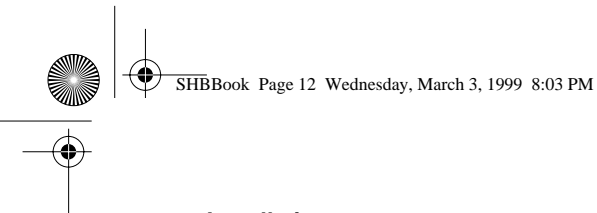

Figure 2-11 MII Module Slot on rear panel





Installation

Powering on the Hub

The NetStacker II hub may be turned on with (or without) LAN segment cables connected.

To power on the hub:

- 1** Connect one end of the power cord (supplied) into the AC power connector on the back panel of the hub.
 - ◆ *Note:* NetStacker II hubs are equipped with an internal power supply. Power sensing is automatic for all international utility power.
- 2** Connect the power cord to a local power source outlet.
- 3** Click the power switch on the rear panel to the "on" position.

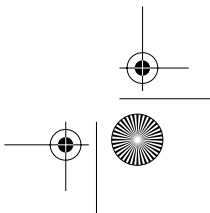
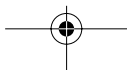
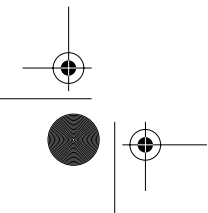
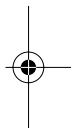
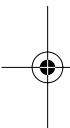

3

LED Indicators

This chapter explains how to interpret the front panel LED indicators on NetStacker II dual speed hubs. There are no LEDs on the rear panel.

The LEDs are used to facilitate monitoring and troubleshooting. These LEDs are:

- Power
- Collision Indicators
- Hub ID Number
- Port Link Activity indicators

The front panel LEDs of the 12 port and 24 port hubs are shown in Figure 3-1 and Figure 3-2.

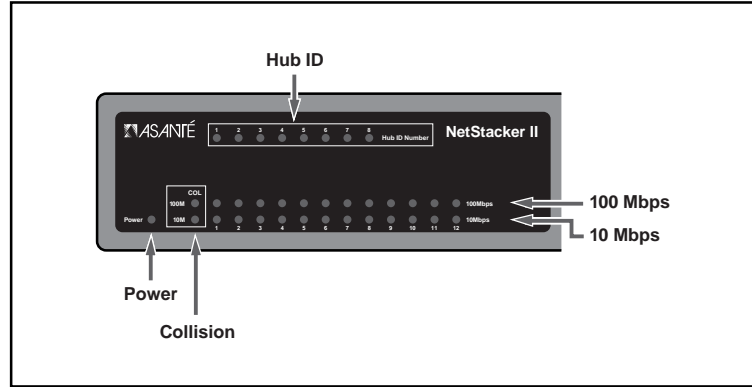

Figure 3-1 12 port hub LEDs

LED Indicators

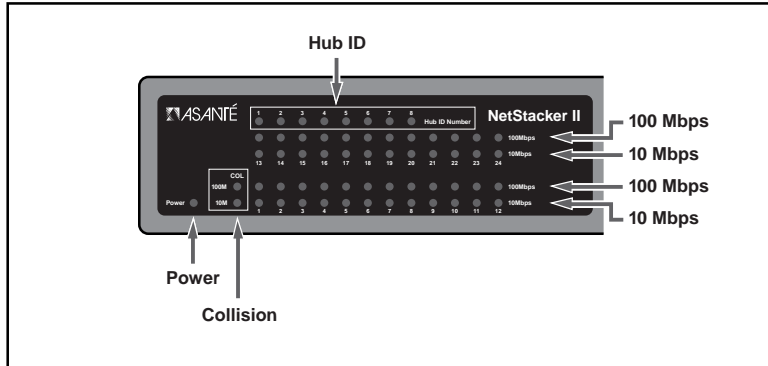

Figure 3-2 24 port hub LEDs

Power LED

The Power LED is green and should always be lit when the NetStacker II is in use. After power is turned on, the LED indicators should respond as follows:

- All LED indicators blink momentarily. This represents a system reset.
- The Port Link Activity LEDs blink on. The ports that are not connected then blink off.
- The Power LED lights and remains ON.

If the Power LED is not lit, check to make sure that the power cord is properly connected at both ends. If the Power LED still remains unlit, determine whether the outlet is functional by plugging another device into it.

Collision Indicator LEDs

The collision indicator LEDs (labeled "COL") are amber. The lower LED indicates collisions on a 10Mbps segment connected to the hub, and the upper LED indicates collisions on a 100Mbps segment connected to the hub. The default condition of these indicators is unlit. A collision occurs when two or more stations in the Ethernet network attempt to transmit data at the same time. If a collision is detected, the appropriate LED flashes while the stations re-transmit. Collisions may be expected when two or more workstations are connected to a hub. These collisions are a normal feature of ethernet traffic, and are not a problem due to re-transmission.

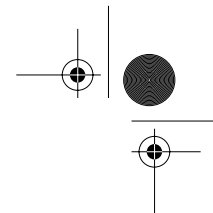
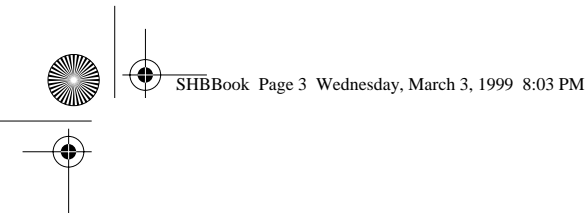

Hub ID Number LEDs

Hub ID Number LEDs

The Hub ID LEDs are a numbered row of eight green LEDs. If your NetStacker II hub is configured with other NetStacker II hubs in a stack, each hub will get an auto-configured ID number, and the LED for that number will be lit on each hub. If your hub is not part of a stack, the LED for ID number 1 will be lit.

If no Hub ID LED is lit on your NetStacker II hub, or if more than one hub in a stack has the same ID number lit, there is a problem with the system. Check with Asanté technical support.

Port Link Activity Indicator LEDs

All NetStacker II hubs include both 100Mbps and 10Mbps Link Activity LED indicators for each port. These are the double rows of numbered green LEDs, labeled "100Mbps" and "10Mbps". On the 12 port hub, the ports and LEDs are numbered 1-12. On the 24 port hub, ports and LEDs are numbered 1-24.

10Mbps Link Activity LEDs

The green 10Mbps LEDs (the lower row) indicate whether the ports are connected and if 10Mbps link pulses are detected at the port. If the 10Mbps link pulse is detected, the LED will be lit. The LED will blink when data is transmitting on the link.

100Mbps Link Activity LEDs

The green 100Mbps LEDs (the upper row) indicate whether the port is connected and if 100Mbps link pulses are detected. If the 100Mbps link pulse is detected, the LED will be lit. The LED will blink when data is transmitting on the link.

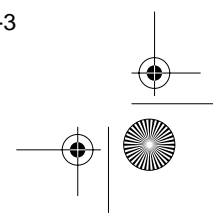
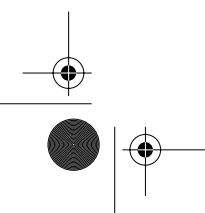
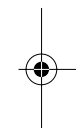
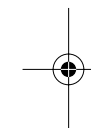

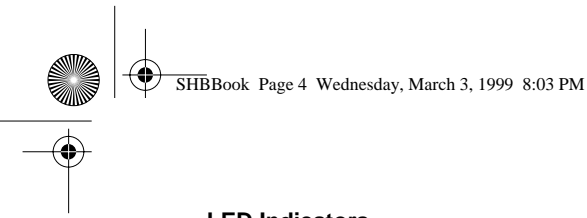

LED Indicators

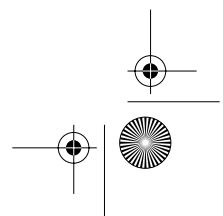
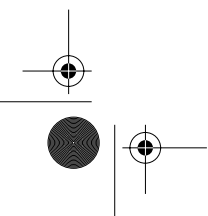
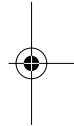
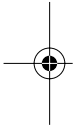
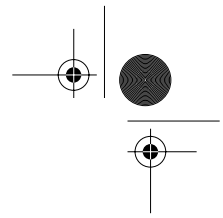

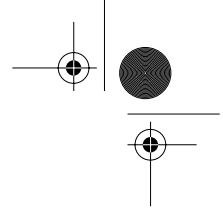

A Troubleshooting

Table A-1 describes how to troubleshoot problems with your network and/or the Switch by monitoring the Switch's LEDs.

Table A-1 Troubleshooting

Problem	Indication	Action
No Power	Power LED OFF	Check the power cord. Make sure the power outlet is functional. Make sure the power cord is properly connected to the outlet and is securely connected to the hub.
Port connection not functioning	Link Activity LED OFF	Make sure the cable is functioning and is properly connected at both ends. Check the crimp of the RJ-45 connectors. Make sure the UTP cable is Category 5 for 100Base-TX. Make sure the UTP cable is Category 3 for 10Base-T. Make sure the cable length does not exceed 100 meters.
Hub ID incorrect	No HUB ID LED lit, or same HUB ID LED lit on two hubs	Check with Asanté technical support.

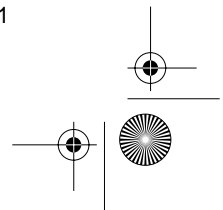
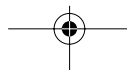
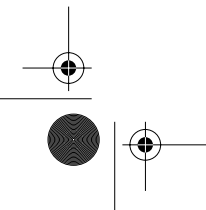

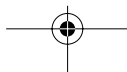
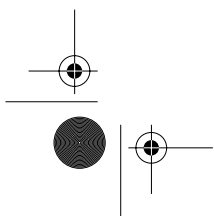
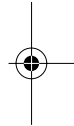
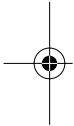
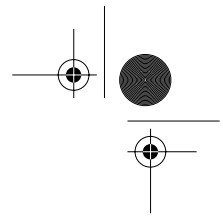
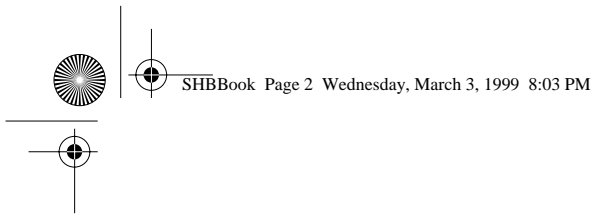

B Specifications

NetStacker II Hub Specifications

Standard	IEEE 802.3 Ethernet standard IEEE 802.3u Fast Ethernet standard
Interfaces	RJ-45 (TP) X 12/24 Stackable connector X 2 MII expansion slot for 100Base-FX module
Stackable	Up to 8 units
Indicators	System: Power LED Hub ID LEDs Segment: 10Mbps collision LED 100Mbps collision LED Per Port: 10M link activity LED 100M link activity LED
Power	100VAC/60Hz to 240VAC/50Hz
Environment	Temperature: Operating: 0° C to 40° C (32° F to 104° F) Storage: -20° C to 70° C (-4° F to 158° F) Humidity: Operating: 10%RH to 90%RH Storage: 5%RH to 90%RH
EMI	FCC Class A, CE, VCCI 1
Dimensions	438mm X 257mm X 44,5mm (17.25" X 10.125" X 1.75")
Safety Regulations	CUL (UL and CSA) LVD
Weight	6.75 lbs (12 Port) 7.35 lbs (24 Port)

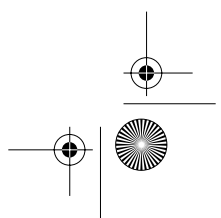
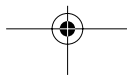
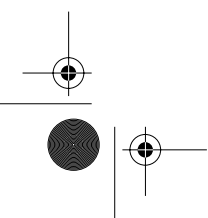
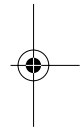
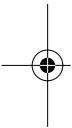
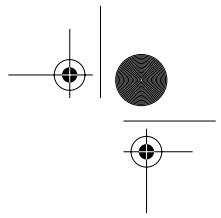
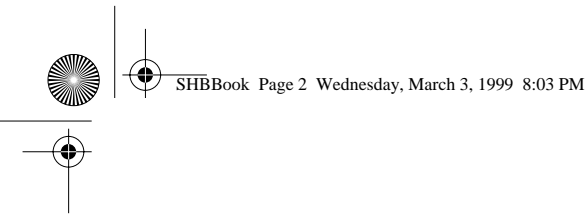



C

Technical Support

Contacting Technical Support

To contact Asanté Technical Support:

Telephone	(800) 622-7464
Fax	(801) 566-3787
Fax-Back	(800) 741-8607
E-mail	support@asante.com
World Wide Web Site	http://www.asante.com

Technical Support Hours

6:00 a.m. to 5:00 p.m. Pacific Standard Time USA, Monday - Friday.

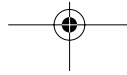
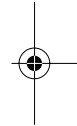
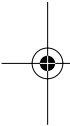

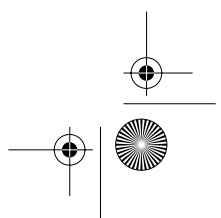
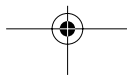
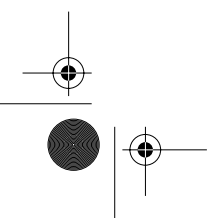
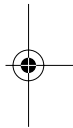
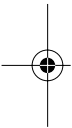
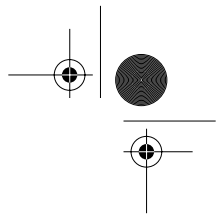
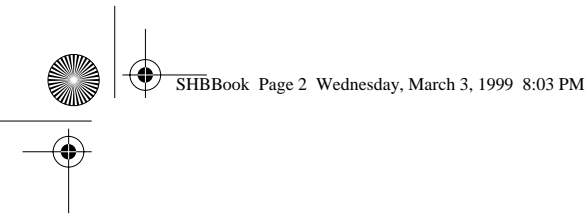

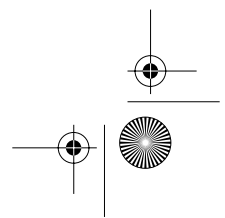
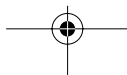
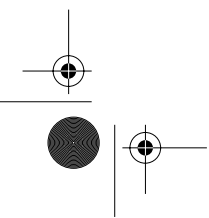
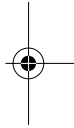
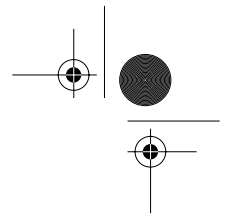
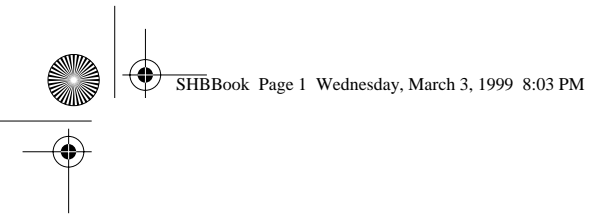

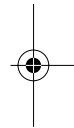
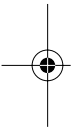
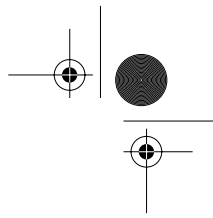
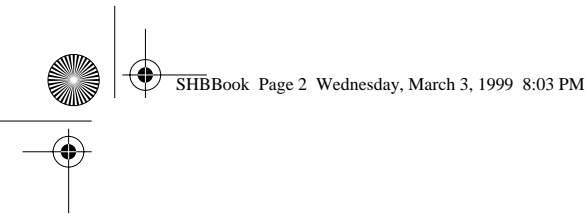

ASANTÉ TECHNOLOGIES, INC., 821 FOX LANE, SAN JOSE, CA 95131

PHONE: 800.622.7464 • FAX: 801.566.3787 • e-mail address: sales@asante.com •
World Wide Web site: <http://www.asante.com>

©1999 Asanté Technologies Inc. Asanté is a trademark of Asanté Technologies, Inc.
All brand names and products are trademarks or registered trademarks of their respective holders.

March 1999 P/N 06-00507-00

