

Quick Guide



Thank you for choosing

Asante Irrigation Controller Kit

For first time installation, please make sure that the Asante Products and your router are within close proximity to each other (preferably 2 feet distance). Once configured, they can be moved to desired locations.

Asante Irrigation Controller is designed for indoor use only. Please install indoors in a dry location.



Asante Home Extender ports and lights

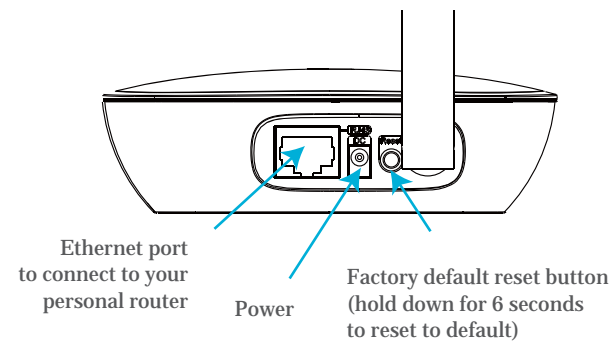

Asante Irrigation Controller ports and lights

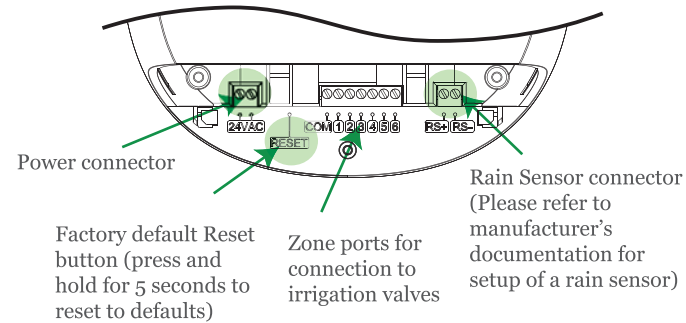
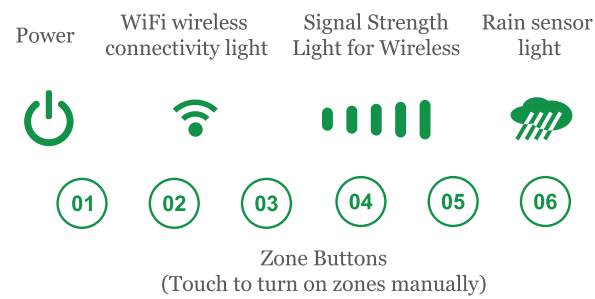

Step 1 Connection to the router

Using the RJ45 Ethernet cable provided, connect the Asante Home Extender to a LAN port on your router.

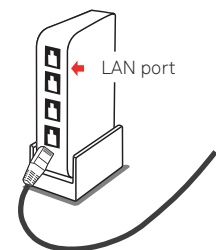

Step 2 Power

1. Connect the power to Asante Home Extender and make sure power light comes on.
2. Cloud light comes on usually after 1 to 3 minutes depending on the Internet connection.

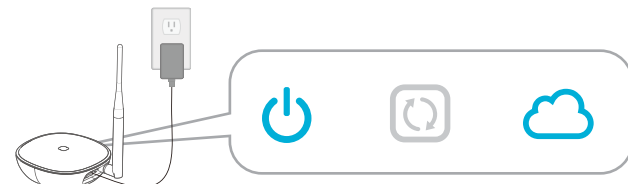

Step 3 Download app and device discovery

*** Connect Smartphone to same WiFi router that Asante Home Extender is connected to.**

1. Download free app from Apple Store or Google Play
Simply search for **Asante Smart Home**
2. Create an account and sign in
3. Claim your first Asante Home Extender when prompted

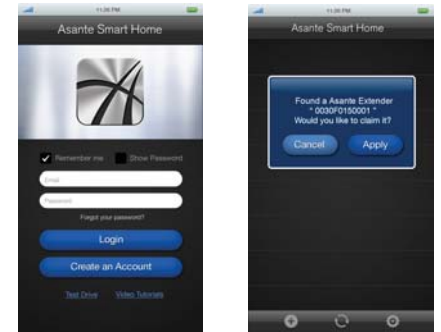

*** If your Smartphone can not connect to same WiFi router, use the procedure below to manually add the device.**

1. Login to app and click the + sign as shown
2. Enter the MAC address that appears on the back of Asante Home Extender in the fields provided and click on apply.



Step 4 Installation of Irrigation Controller

1. Attach the wires from the AC power adapter to the pins on the Irrigation Controller as show below and power up the unit. Polarity does not matter. In some cases this step has been done from factory.
2. LED lights on Asante Irrigation Controller will start to blink indicating a WiFi pairing with Asante Home Extender.
3. Asante Home Extender pairing light will blink until the wireless connection has been established.
4. Claim your first Irrigation Controller when prompted in the app
5. Move the Irrigation Controller to your desired location to prepare for installation.

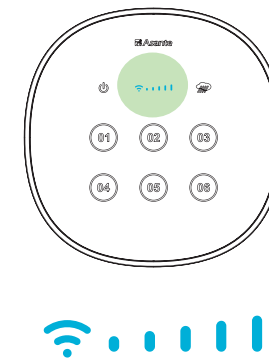
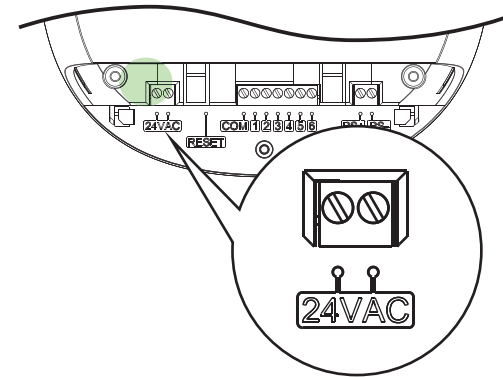

Step 5 Attaching the irrigation valve wires to Irrigation Controller

Asante Irrigation Controller can support up to 6 zones. If you are replacing your old unit with Asante Irrigation Controller, you can use the same wires that are attached to your old unit.

1. Unplug your old unit from the power. Before disconnecting the valve wires, mark each one. Look for Common wire and mark it accordingly.

2. Disconnect the power from Asante Irrigation Controller

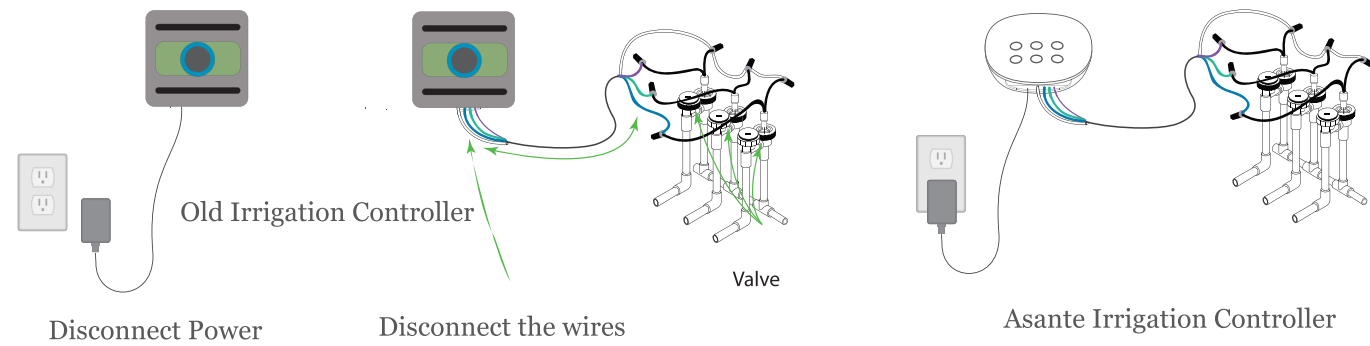

3. Connect the Common wire going to all valves to the common pin on Asante Irrigation Controller.

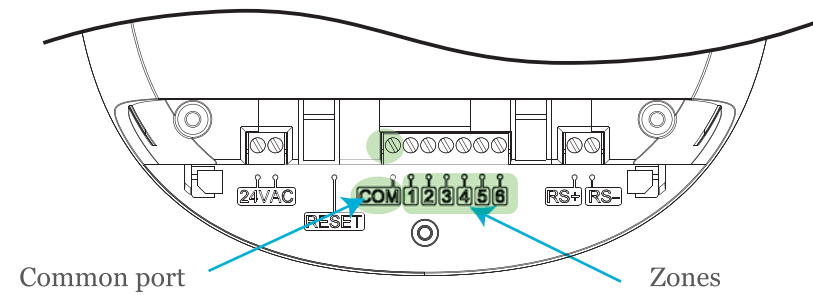

4. Connect the other wires to any of the pins provided. You can determine which pin controls which valve later.

Or if you are aware which wire controls which valve, you can connect them as you desire.

5. Reconnect the power to Asante Irrigation Controller

6. Verify after few seconds that the WiFi light is on

7. Load the app and navigate to zone section

8. Slide the zone button to on and then check for water flow from the valves to determine which zone is controlling which valve.

9. Try each zone individually to test and mark them accordingly

Step 6

Mounting the Irrigation controller on the surface

1. Using stencil provided, place it flat at the location that the unit will be installed and mark the holes.

2. Insert screws and tighten clockwise at the location of the holes. Do not fully tighten against the wall. Leave some space so that the irrigation controller can sit on the screws as shown below.

Mounting holes

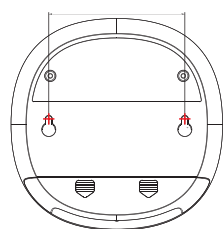

Mounting stencil

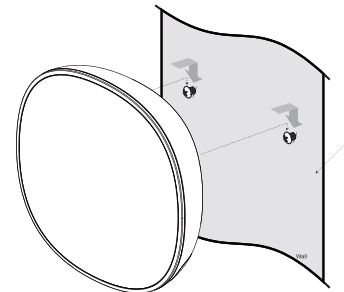
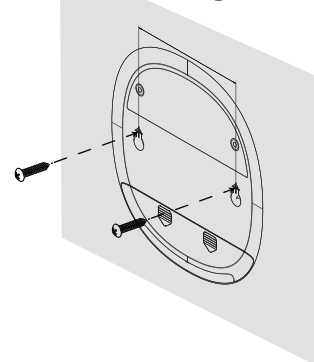

Step 7

WiFi setup for Asante Home Extender (Optional)

Asante Home Extender wireless bridge mode can extend your wireless coverage in a large size property. For areas larger than 5000 sq.ft, consider placing the Asante Home Extender in a **central location** to bridge Asante devices into your home router. Otherwise we strongly recommend using the Ethernet wired mode. If you still want to use the wireless option, please follow the procedure below.

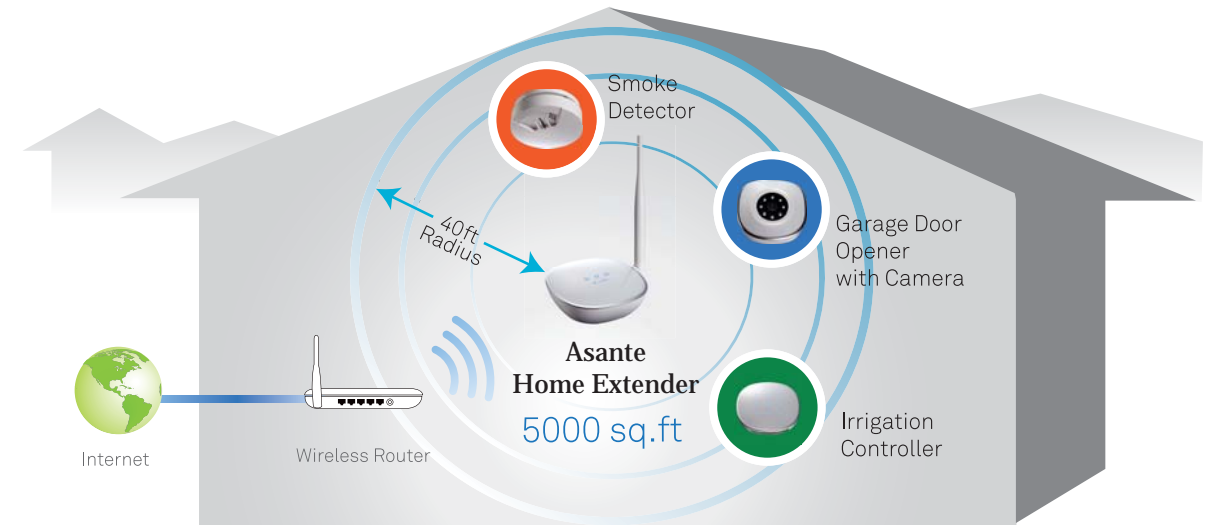

Use wireless connection to maximize the WiFi coverage. Asante Home Extender can cover up to 5000 sq.ft

1. Login to app and select the settings button as shown below

2. Select WiFi manager

3. Select your home router from the list

4. Enter your personal wireless password that has been setup on your router when prompted

Once connected, you can disconnect the Ethernet cable between the Asante Home Extender and router and move the Asante Home Extender to appropriate location. The lights on the Asante Home Extender will indicate a wireless signal.

