

Quick Guide



Thank you for choosing

Asante Smoke Detector Kit

For first time installation, please make sure that Asante products and your router are within close proximity to each other. Once configured, they can be moved to desired locations. It is very important to add one Smoke Detector at a time. Insert battery into one unit, claim on the app and then move on to the next.



Asante Home Extender ports and lights



Power Wireless Pairing Light Cloud Light



WiFi wireless connectivity light



Signal Strength Light for Wireless

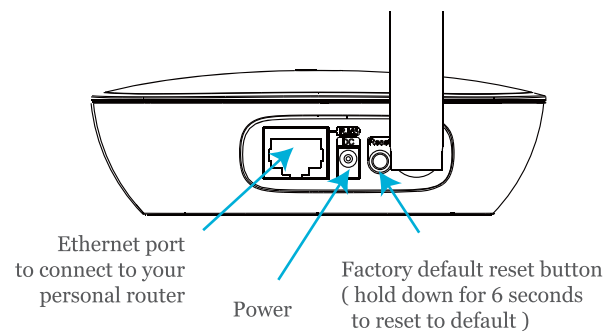

Asante Smoke Detector ports and lights

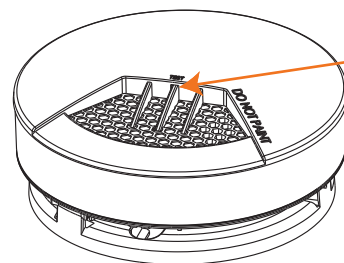

Test Button (LED Light)

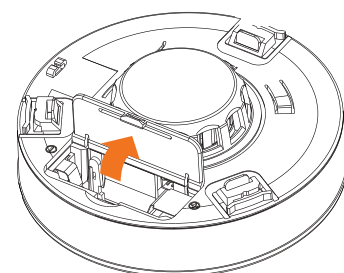

Inserting battery into Smoke Detector

Step 1 Connection to the router

Using the RJ45 Ethernet cable provided, connect the Asante Home Extender to a LAN port on your router.

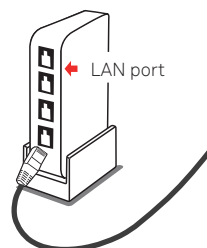

Step 2 Power

1. Connect the power to Asante Home Extender and make sure power light comes on.
2. Cloud light comes on usually after 1 to 3 minutes depending on the Internet connection.

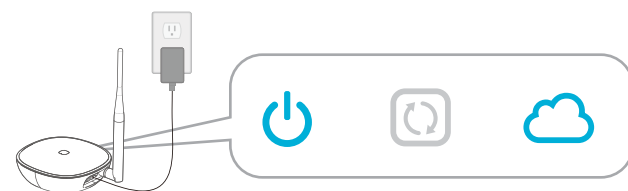

Step 3 Download app and device discovery

* **Connect Smartphone to same WiFi router that Asante Home Extender is connected to.**

1. Download free app from Apple Store or Google Play
Simply search for **Asante Smart Home**
2. Create an account and sign in
3. Claim your first Asante Home Extender when prompted



* **If your Smartphone can not connect to same WiFi router, use the procedure below to manually add the device.**

1. Login to app and click the + sign as shown
2. Enter the MAC address that appears on the back of Asante Home Extender in the fields provided and click on apply.

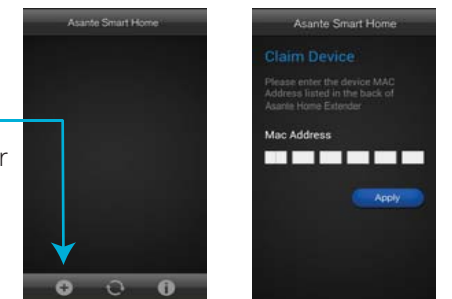

Step 4 Setup of Smoke Detector

1. Remove the base from the smoke detector
2. Insert battery into smoke detector and close the lid. Inside the battery compartment there is a red lever that will be pushed down when inserting the battery.
3. Claim your first Smoke Detector when prompted in the app.
4. Before installing additional Smoke Detectors, rename the one that you just installed. This way each Smoke Detector will have a specific name.

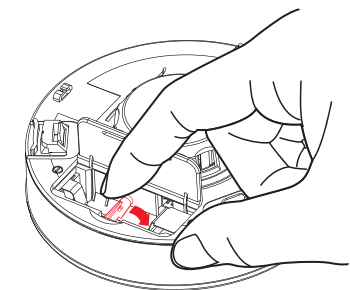

Repeat steps 1-4 for any additional Smoke Detectors you might have.

Step 5 Location test and mounting instruction

To ensure a reliable communication between the Smoke Detector and Asante Home Extender, the following steps should be taken. It is a good idea to do the test holding the Smoke Detector in an upside down position just like if it was attached to ceiling.

1. Login to app using your Smartphone and enter the setting page for Smoke Detector. click on Location Test button as shown
2. Press the test button on the Smoke Detector and make sure you receive a test response on your app
3. Now move the Smoke Detector to the location that it will be installed
4. Repeat steps 1-3 to make sure Smoke Detector is still within the communication range. If you received a response on the app, then you are done. Proceed with mounting of the unit.
5. If you do not get a response from Smoke Detector at the location that the unit needs to be installed, then consider relocating Asante Home Extender. To do this, please see step 7.

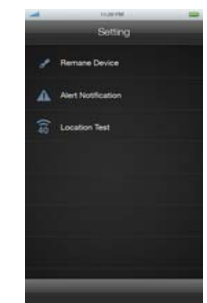
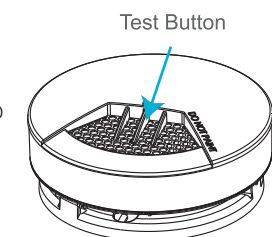

Step 6

Mounting instruction for Smoke Detector

1. Remove the mounting base from the Smoke Detector (counter clockwise) and hold it against the ceiling surface that you would like to install the unit.
2. Mark the screw holes using a pen or pencil as shown below and Tighten the base to the surface using the screws provided.
3. Holding the smoke detector firmly into base, turn it clockwise to lock
4. You can also do the Location Test one more time to confirm the correct location for Smoke Detector.

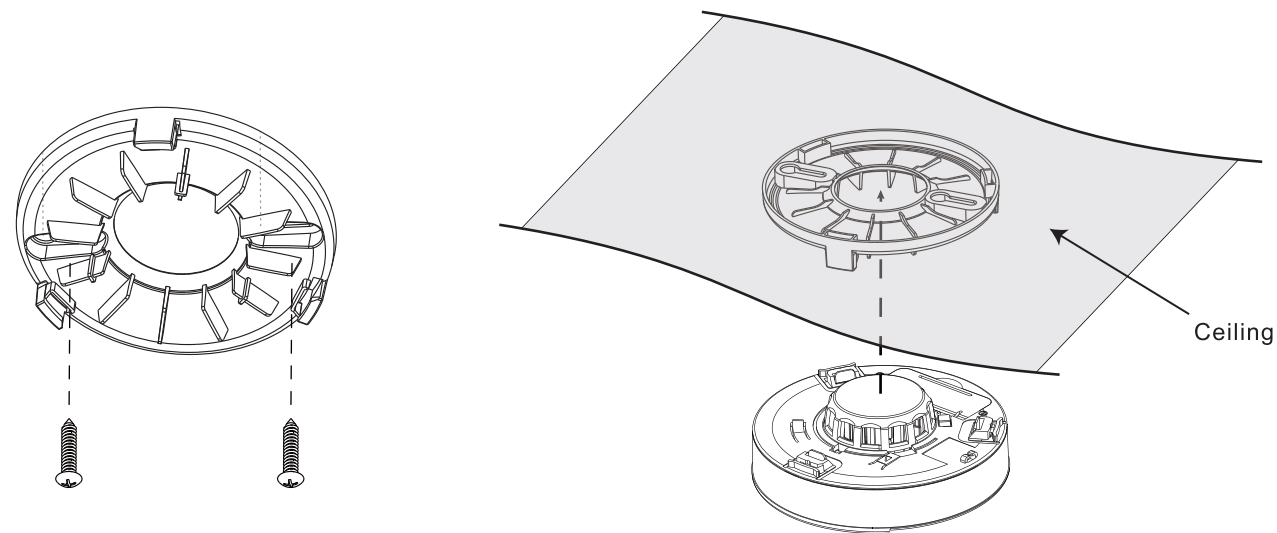

Test Button and LED Light

In standby mode

The red LED, as the ALARM indicator, are featured with the Asante Smoke Detector Alarm.

It can be seen through the clear test button on the cover of the unit. When red LED flashes every 334 seconds, it indicates that the Smoke Detector is under normal operation. When Smoke Detector senses smoke; it sounds an alarm with 3 beeps, pause and 3 beeps. The red LED will flash continuously and rapidly.

Silence Feature

The silence feature can temporarily turn off sound for up to 10 minutes.

To use this feature, press test button on the cover when alarm goes off.

If the smoke concentration around the Smoke Detector is still at an alarming level after 10 minutes of silence, the unit will re-alarm immediately.

Low Battery Warning Signal

If the alarm horn begins to chirp once in 43 seconds with red and yellow LED flashing, it indicates that the Smoke Detector battery is weak. This low battery warning signal should last for up to 30 days. However, you should replace battery immediately upon receiving this signal for continuous protection.

Tamper Switch Feature

If the Smoke Detector is not mounted into the bracket properly during the first 5 minutes after battery is installed, the tamper function is triggered and the yellow LED stays on.

If the Smoke Detector is still not mounted into the bracket properly 5 minutes after battery is installed, you will hear three beeps with yellow LED steadily on until smoke alarm is mounted back into bracket.

Testing Your Smoke Detector

Test the Smoke Detector weekly by pressing the test button and holding it for around 4 seconds until the alarm sounds. The sound pattern is 3 beeps, pause, and then 3 beeps with red LED flashing continuously and rapidly.

Step 7

WiFi setup for Asante Home Extender (Optional)

Asante Home Extender wireless bridge mode can extend your wireless coverage in a large size property. For areas larger than 5000 sq.ft, consider placing the Asante Home Extender in a central location to bridge Asante devices into your home router. Otherwise we strongly recommend using the Ethernet wired mode. If you still want to use the wireless option, please follow the procedure below.

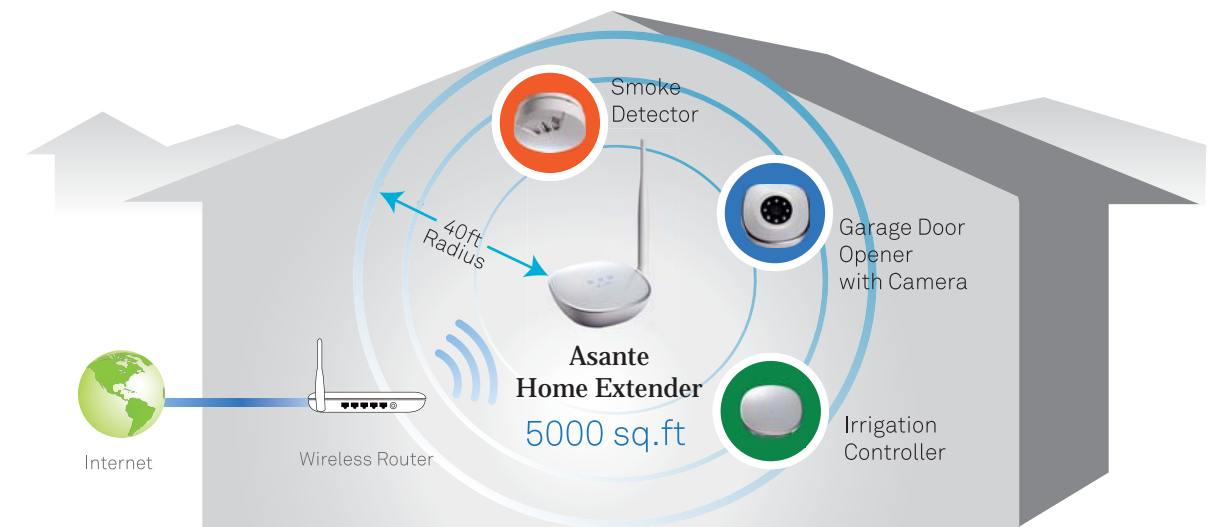

Use wireless connection to maximize the WiFi coverage. Asante Home Extender can cover up to 5000 sq.ft

1. Login to app and select the settings button as shown below
2. Select WiFi manager
3. Select your home router from the list
4. Enter your personal wireless password that has been setup on your router when prompted

Once connected, you can disconnect the Ethernet cable between the Asante Home Extender and router and move the Asante Home Extender to appropriate location. The lights on the Asante Home Extender will indicate a wireless signal.

